

**People's Democratic Republic of Algeria**  
**Ministry of Higher Education and Scientific Research**  
**University of Ghardaia**



**Faculty of Letters and Languages**  
**Department of English**

**Investigating the Effectiveness of Competency-Based  
Approach (CBA) in Developing Primary Education Pupils'  
English Comprehension Ability.  
The case of 3<sup>rd</sup> year pupils of Ibn Badis primary school  
Metlili**

*Dissertation submitted to University of Ghardaia for obtaining the Master's degree  
in Didactics*

Submitted by:

Amra DJAIDIR

Zineb MAHDJOUB

Supervisor:

Mr.Tahar MEKLA

**Academic year: 2022/2023**

## **Acknowledgements**

We thank Allah, for providing us with strength and patience to finish this work .We praise Him and glorify Him as he ought to be praised and glorified.

A deep sense of gratitude goes to our supervisor **Mr. MEKLA Tahar** for being kind enough to accept supervising us and for his guidance and support despite all of his academic and personal engagements.

A special thanks goes to our professor **Dr.Malika KOUTI**, we would like to express my sincere gratitude to **Dr.BELARBI Ahmed Nourdine** Kasdi Merbah University of Ouargla for his help and advice, To all of our professors **Dr.ABDELHAKEM, Dr.KHODBANE, Dr. YUCEF, Dr.BEN GHEZALA, Dr.GHANI** and **Dr.ALLAOUI** to all teachers at the Section of English, University of Ghardaia. Our pure gratefulness and respect for all the teachers.

Our special thanks to ABDELHAMID IBN BADISS school teacher **Ms.Zineb SIRADJ** who has helped us to produce this work.

Our thanks also go to all those who contributed to our work in one way or another. To all the administration workers in our department for their help and services.

## DEDICATION

In the Name of Allah, the Most  
Merciful, the Most Compassionate this  
work is dedicated to my father  
God bless his soul.

To my mother, my first teacher in my life  
who has teach me my first word to talk and  
my first step to walk.

To all the members of my family, particularly, my brother and  
sisters. I thank you all for  
Your endless help and encouragement along  
my studies.

This work is also dedicated to my  
classmates.

My special dedication goes to all  
my teachers.



*Amra*

## DEDICATION

I dedicate this work to my beloved mother, who with  
being my mother, inspired me all along my life  
journey

To my beloved sisters

Zoulikha, Salima, Hadjira, Donya, Ahlam and Amina

To my nephews and nieces

To my twin Nafissa. I thank you all for

Your endless encouragement along  
my studies.

My special dedication goes to my colleagues

Nourelhouda, Amra, Sara, Rayan, Amel, Faycal and all  
of my classmates

Thank you for being by my side...



**Zineb**

## ABSTRACT

---

### ABSTRACT

The current context witnesses the introduction of English –as a new language –in primary school and the competency –based approach as one of a variety of learning approaches .The Algerian schools introduced it into the English language syllabus in terms of the pupils' needs. The purpose of this study is to investigate the 3rd year primary school pupils' English comprehension ability development, and to identify their comprehension ability under the competency-based approach. The study was conducted with a sample of 7 teachers of English and 57 3<sup>rd</sup> grade learners pupils at Ibn Badiss primary school in Metlili. The researchers used a questionnaire, a test and an interview for data collection. The findings of the study revealed that most teachers have a good understanding of CBA in what relates to its theoretical aspects, yet, it is not the case concerning practice. On the other hand, most of pupils prefer the listening and speaking skills rather than the reading and the writing skills.

**Key Words: competency–based approach, English comprehension ability , language skills, Ibn Badiss primary school.**

## List of tables

---

<b>Table 01: Topics and Communicative Objectives CNP (2022p.08).....</b>	<b>29</b>
<b>Table 02: Relying on textbook.....</b>	<b>39</b>
<b>Table 03: The use of mother tongue in classroom explanation.....</b>	<b>40</b>
<b>Table 04: The use of CBA.....</b>	<b>41</b>
<b>Table 05: The teacher’s role in the CBA.....</b>	<b>42</b>
<b>Table 06: Learner’s interaction .....</b>	<b>43</b>
<b>Table 07: Skills that pupil prefer .....</b>	<b>43</b>
<b>Table 08: Learner’s praising.....</b>	<b>44</b>
<b>Table 09: Materials used in the classroom.....</b>	<b>45</b>
<b>Table 10: Textbook help learners to work in pairs or groups .....</b>	<b>46</b>
<b>Table 11: Textbook and pupil’s level.....</b>	<b>47</b>
<b>Table 12: pupils' evaluation .....</b>	<b>48</b>
<b>Table 13: Classroom interaction.....</b>	<b>48</b>
<b>Table 14: The time for teaching English .....</b>	<b>49</b>
<b>Table 15: Teaching large classes .....</b>	<b>50</b>
<b>Table 16: The number of pupils in each class.....</b>	<b>51</b>
<b>Table 17: The needed materials .....</b>	<b>52</b>
<b>Table 18: Instruction and guidance.....</b>	<b>52</b>
<b>Table 19: Engaging and interaction of learners with the learning process .....</b>	<b>53</b>
<b>Table 20: Difficulties in teaching at different schools.....</b>	<b>54</b>
<b>Table 21: The causes behind classroom’s problems .....</b>	<b>55</b>
<b>Table 22: Activity 01 Listen then match .....</b>	<b>56</b>
<b>Table 23: Activity 02 Trace and write.....</b>	<b>57</b>
<b>Table 24: Activity 03 Read and do the same with your friend.....</b>	<b>59</b>
<b>Table 25: Activity 04 speaking comprehension .....</b>	<b>60</b>

## List of Figures

---

<b>Figure 01: Components of the CBA (Weddel, 2006)</b> .....	<b>13</b>
<b>Figure 02: Relying on textbook</b> .....	<b>40</b>
<b>Figure 03: The use of mother tongue in classroom explanation</b> .....	<b>41</b>
<b>Figure 04: The use of CBA</b> .....	<b>41</b>
<b>Figure 05: The teacher’s role in the CBA</b> .....	<b>42</b>
<b>Figure 06: Learner’s interaction</b> .....	<b>43</b>
<b>Figure 07: Skills that pupil prefer</b> .....	<b>44</b>
<b>Figure 08: Learner’s praising</b> .....	<b>45</b>
<b>Figure 09: Materials used in the classroom</b> .....	<b>46</b>
<b>Figure 10: Textbook help learners to work in pairs or groups</b> .....	<b>46</b>
<b>Figure 11: Textbook and pupil’s level</b> .....	<b>47</b>
<b>Figure 12: pupils' evaluation</b> .....	<b>48</b>
<b>Figure 13: Classroom interaction</b> .....	<b>49</b>
<b>Figure 14: The time for teaching English</b> .....	<b>50</b>
<b>Figure 15: Teaching large classes</b> .....	<b>50</b>
<b>Figure 16: The number of pupils in each class</b> .....	<b>51</b>
<b>Figure 17: The needed materials</b> .....	<b>52</b>
<b>Figure 18: Instruction and guidance</b> .....	<b>53</b>
<b>Figure 19: Engaging and Interaction of learners with the learning process</b> .....	<b>53</b>
<b>Figure 20: Difficulties in teaching at different schools</b> .....	<b>54</b>
<b>Figure 21: The causes behind classroom’s problems</b> .....	<b>55</b>
<b>Figure 22: Activity 01 Listen then match</b> .....	<b>56</b>
<b>Figure 23: Activity 01 Listen then match</b> .....	<b>57</b>
<b>Figure 24: Activity 02 Trace and write</b> .....	<b>57</b>
<b>Figure 25: Activity 02 Trace and write</b> .....	<b>58</b>
<b>Figure 26: Activity 03 Read and do the same with your friend</b> .....	<b>58</b>
<b>Figure 27: Activity 03 Read and do the same with your friend</b> .....	<b>59</b>

## List of Figures

---

<b>Figure 28: Activity 04 speaking comprehension.....</b>	<b>60</b>
<b>Figure 29: Activity 04 speaking comprehension.....</b>	<b>61</b>



# LIST OF ABBREVIATIONS

---

## List of Abbreviations

**ALM:** Audio-lingual Method

**CBA:** Competency-Based Approach

**CLT:** Communicative Language Teaching

**DeSeCo:** Definition and Selection of Competencies

**DM:** Direct Method

**EFL:** English as a Foreign Language

**ELT:** English Language Teaching

**GTM:** Grammar Translation Method

**L1:** First language

**L2:** Second Language

**TEFL:** Teaching English as Foreign Language

## Table of Contents

---

Acknowledgements .....	I
Dedication .....	II
Abstract.....	III
List of Tables .....	VI
List of Figures.....	VII
List of Abbreviations .....	IX
Table of contents .....	III

### General Introduction

1. Background .....	01
2. Statement of the Purpose .....	01
3. Statement of the Problem.....	02
4. Motivations .....	02
5. Research Methodology and Data Collection Tools.....	02
6. Structure of the Dissertation.....	03
7. Limitation of the Study.....	04
8. Definition of Terms .....	04

### Part One: Theoretical part

#### Chapter One: Framework of competency-based approach

Introduction.....	06
1. Definition of: Approach, Method, and Technique.....	06
2. An Overview of Major Methods and Approaches in Language Teaching.....	07
2.1. Grammar Translation Method.....	07
2.2. The Direct Method.....	08
2.3. The Audio Lingual Method.....	09
2.4. Communicative Language Teaching.....	09
3. Competency Based Approach.....	11
3.1. A brief background history of the CBA.....	11
3.2. Difference between Competence and Competency .....	13
3.2.1. Definition of Competence .....	13
3.2.2. Definition of Competency.....	14
3.3. Definition of the CBA .....	12
3.4. Characteristics of the CBA .....	13
3.5. Principles of the CBA .....	14

## Table of Contents

---

3.5.1. Principles concerning the learner .....	17
3.5.2. Principles concerning the teacher .....	18
3.5.3. Components of CBA .....	18
3.6. The pupils' role in the CBA .....	19
3.7. The teachers' role in the CBA .....	19
4. The CBA in the Algerian primary school.....	22
Conclusion .....	22

### Chapter Two : Pupils comprehension ability

Introduction.....	23
1. Definition of comprehension .....	23
2. Comprehension Abilities .....	23
2.1. Reading .....	23
2.2. Writing.....	24
2.3. Listening .....	25
2.3.1. Listening comprehension .....	26
2.3.2. The importance of Listening.....	28
2.4. Speaking.....	28
3. Teaching English at Primary Schools .....	29
3.1. The types of tasks and activities in the classroom.....	30
3.2. Lesson planning.....	31
3.2.1. Presentation of the Problem-solving Situation.....	31
3.2.2. Systematization .....	31
3.2.3. Application .....	31
3.2.4. Partial Integration Activities .....	31
3.3. The use of materials in the classroom .....	31
3.3.1 Textbooks as a Teaching Material .....	31
3.3.1.1 What is a textbook? .....	32
3.3.2 Textbook of 3rd year primary school .....	33
3.3.2.1. Topics and Communicative objectives .....	34
3.3.3 Role of the Textbook in the Classroom.....	34
3.4.The evaluation under the CBA .....	36
Conclusion .....	36

## Table of Contents

---

### Part Two: Practical part

Introduction.....	37
1. The Sample .....	37
2. Data Collection.....	37
2.1. The questionnaire .....	37
2.2. The test.....	33
2.3. The interview.....	34
3. Data Analysis.....	34
3.1. Analysis of the questionnaire .....	35
3.2. Analysis of the test .....	54
3.3. Analysis of the interview .....	60
4. Discussion of the results .....	62
Conclusion .....	62
General conclusion.....	
References.....	
Appendices.....	
ملخص.....	

# General Introduction

---

## **1. Background**

Currently, English has become the property of almost all the cultures around the world, for it is increasing the capacity of people to communicate and exchange ideas across borders. It constitutes the official language in many countries and occupies a prominent position in many others.

Though the English language was adopted in the Algerian school system, starting from the primary stage, as a foreign language, and not an alternative foreign language, the teaching of English has become part of the primary school system starting with the new school year 2022/2023, this year was limited to third-year (age of 8 or 9) primary pupils only. The teaching and learning of English as a foreign language (EFL) has always been difficult and challenging. That it involves non-native speakers who are learning a third language after the mother tongue (L1) and French (L2). Teaching English to third-year primary school pupils may seem like a challenging task for both the teacher and their pupils, as a result of the limited understanding of this new language, which is under study. Primary school pupils differ in terms of each individual's ability to understand, comprehend, and focus on learning English language. Therefore, some teachers may notice the limited interactions of students and their lack of focus in carrying out tasks assigned to them, and thus the weakness in the development of their academic skills such as pronunciation, speaking, reading and writing. The introduction of English in Algeria as a foreign language meets challenges in learners' attitude and in teachers' instruction.

## **Statement of the Purpose**

The teaching of English has known many approaches among which: the Grammar Translation Method, the Direct Method, the Audio-lingual Method, the Communicative Language Teaching and the Competency Based Language Teaching.

However, there are many difficulties involved in the construction and administration of any comprehension tasks for both teachers and their pupils. Therefore, this study came as an attempt to find out the impact of the competency –based approach on the comprehension ability of pupils. In this case, the study of the pupils' interactions and responses to everything they have learned in their educational environment (classroom) during his journey of learning this new language. The main objective of this study is to assess the implementation of the CBA in TEFL in Algeria.

### **3. Statement of the Problem**

The study investigates whether this new approach is effectively practiced in primary schools in Algeria. This study aims at assessing teachers' awareness of the CBA and their ability to use the approach in their classrooms. Equally, it sets out to check students' involvement in classroom activities and find out about prior preparation for the implementation of the CBA in schools.

### **4. Research Questions and Hypotheses:**

To attain these objectives, this study is guided by the following **research questions**:

- How does competency-based approach affect pupils' comprehension?
- What are pupils' attitudes toward competency-based approach?

The investigation throughout this work will attempt to provide arguments for the following **research hypotheses**:

- Competency –based approach helps increase pupils' comprehension.
- Pupils display positive attitudes toward competency-based approach.

### **5. Motivations:**

It is important to investigate whether the use of competency-based approach has a positive effect in developing primary education pupils' English comprehension ability (reading, writing, listening and speaking). The results of this study are very important. It can help the designers of textbook, teachers of English and educators to go deeper into the most effective approaches to use for teaching pupils' English language.

### **6. Research Methodology and Data Collection Tools**

In order to find out to which extent these hypotheses are true, we have opted for a certain methodology to evaluate the teaching of the four skills in the Algerian English classrooms. A case study was chosen to investigate a randomly selected sample of 57 third-year primary school pupils from Ibn Badis –Metlili, and seven (07) teachers (from all the primary schools of Metlili (32 primary schools) each one of them teach in four or five schools) using a mixed method approach which includes the use of both quantitative and qualitative approaches for the sake of collecting data. Three research instruments have been utilized in order to the

## General Introduction

---

results including a questionnaire administered to the teachers and interview to the teacher and a structured test prepared for pupils.

### **7. Structure of the Dissertation**

This research work is composed of a general introduction and two interrelated parts that are linked to enlighten the reader on this work.

- Part one provides a theoretical part which consists of two chapters. Chapter one is an overview of the CBA. Defining the key concepts related to the CBA, the competence, the characteristics, the principles of the CBA the pupils' and teachers' roles in CBA and the CBA, in turn, in the Algerian primary school.

Chapter two describes pupils' comprehension abilities (reading, writing, listening and speaking), The types of tasks and activities in the classroom, Lesson planning, the use of materials in the classroom, Textbooks as a Teaching Material, Textbook of 3rd year primary school, Role of the Textbook in the Classroom and finally demonstrates The evaluation under the CBA.

- Part two sheds light on the sample, the data collection procedures undertaken to answer the research questions and test the hypotheses. Indeed, it is targeted toward the description of the research design i.e., case study and procedures, i.e., the ways in which the research is conducted, involving the approaches utilized for collecting data (a combination of qualitative and quantitative methods), the setting of the study, the research instruments of data collection (teachers' questionnaire, teachers' interview and pupils' test).

It is also devoted to the analysis of the results obtained from the different research tools. In the previous part we have described the design of the present research work which involved the selection of a number of data collection techniques, namely a questionnaire, an interview and a test. The main results obtained from the three data collection methods are going to be systematically analyzed, discussed and interpreted in this part in an attempt to answer the research questions. This part, therefore, stands for the practical part of the study which involves the combined use of both quantitative and qualitative data analysis techniques. It is expected then that results of this investigative study would hopefully provide a thorough diagnosis of the problem under study and would also pave the way to a better testing of research hypothesis so as to propose the direct and indirect role of the CBA in teaching.

### **8. Limitation of the Study**

- Limited number of teachers in primary schools (32 primary schools) each one of them teaches in four or five schools).

## General Introduction

---

- Since the implementation of English at primary school is new, some pupils did not interact with us because they were a little bit afraid.
- There was a lack of resources, especially books which are related to teaching English under the CBA in primary schools.

### 9- Definition of Terms:

**EFL:** abbreviation for English as a Foreign Language: the teaching of English to students whose first language is not English

**L1:** First language: the language that someone learns to speak first.

**L2:** Second Language: a language that a person can speak that is not the first language they learned naturally as a child.

**GTM:** Grammar Translation Method: first method of teaching that was practiced in the 19th century.

**DM:** Direct Method: a technique of foreign-language teaching in which only the target language is used, little instruction is given concerning formal rules of grammar, and language use is often elicited in situational contexts.

**ALM:** Audio-lingual Method: a technique of foreign-language instruction that emphasizes audio-lingual skills over reading and writing and is characterized by extensive use of pattern practice.

**CLT:** Communicative Language Teaching: is also referred to as the communicative approach, which entails teaching language through communication. This approach to teaching language frames communication as both a goal and a method for English language learners (ELLs) whose first language is not English.

**CBA:** Competency-Based Approach: approach allows students to advance based on their ability to master a skill or competency at their own pace regardless of environment. This method is tailored to meet different learning abilities and can lead to more efficient student outcomes.

**DeSeCo:** Definition and Selection of Competencies Project was designed to bring a wide range of expert and stakeholder opinion together, to produce a coherent and widely shared analysis of which key competencies are necessary for coping with the manifold challenges of today's world . Three categories of key competencies – interacting in socially heterogeneous



## General Introduction

---

groups, acting autonomously, and using tools interactively – grounded in a holistic model of competence, constitute a core element of DeSeCo's overarching conceptual framework.

**ELT:** English Language Teaching: the teaching of English to speakers of other languages.

**TEFL:** Teaching English as Foreign Language; the teaching of English to people who are not native speakers of English, especially in a non-English-speaking country.

## Framework of Competency-Based Approach

### Introduction

This first chapter sheds some lights on a key definitions of Approach, Method, and Technique, an Overview of Major Methods and Approaches in Language Teaching, Competency Based Approach, A brief background history of the CBA, Difference between Competence and Competency Definition of the CBA, Characteristics of the CBA, Principles of the CBA, the pupils and teachers role and the CBA in the Algerian primary school.

### 1. Definition of: Approach, Method, and Technique

The three terms are defined in Richards & Schmidt (2002, p. 30) as "Different theories about the nature of language and how languages are learned (The approach) imply different ways of teaching language (The method), and different methods makes use of different kinds of classroom activity (The technique)".

Anthony (1963, p. 63), defines an approach as "a set of correlative assumptions dealing with the nature of language teaching and learning. An approach is axiomatic. It describes the nature of the subject matter to be taught..." ( as cited in Richards and Rodgers, 2014, p. 19). Furthermore, Richards and Rodgers (2014) relied on Anthony's model to explain that an approach is the level at which beliefs and assumptions about language and language learning are specified. Brown (2000) and Davies and Pearse (2009) stood to hold similar positions and maintained that an approach relates to theoretically well-informed positions and beliefs about the nature of language and language learning and how applicable both are to pedagogical situations.

With reference to all these positions, it can be said that an approach is abstract; it relates to the underlying principles of a given learning situation, but additionally to the ways in which those principles can be put into practice. Brown (2002, p. 11) summed it up: "An approach to language pedagogy is not just a set of static principles « set in stone. » It is, in fact, a dynamic composite of energies within a teacher that changes (or should change, if one is a growing teacher) with continued experience in learning and teaching."

A method is an umbrella term. It is rather related to the practical realization of a given approach (Davies & Pearse, 2009). According to Anthony (1963), a method is "an overall plan for the orderly presentation of language material, no part of which contradicts, and all of which is based upon, the selected approach (as cited in Richards and Rodgers, 2001, p. 19).

Davies and Pearse (2009) asserted that behind a method, there is always an approach. More importantly, he added that a method goes further to relate to such elements as the syllabus, the learning activities, and the teaching techniques. Harmer (2001) also explained that a method determines the different types of activities and kinds of materials that can be helpful, but more importantly to the diverse roles both teachers and learners are to play in the classroom.

Given the very similar interpretations of both an approach and a method and because both terms are, by and large, two sides of the same coin, one can easily come to use the terms interchangeably.

According to Anthony (1963), a technique is any kind of stratagem or trick to be actually implemented in the classroom for the sake of accomplishing an immediate objective. He added that there should be some kind of consistency and harmony as to using techniques; the latter should relate the method and be relevant to the underlying approach (as cited in Richards and Rodgers, 2014, p. 19).

## **2. An Overview of Major Methods and Approaches in Language Teaching**

### **2.1. The Grammar Translation Method**

This was the first method of teaching that was practiced in the 19th century. The proponents hold that the fundamental purpose of learning a foreign language is to be able to read literature written in the target language. Also for the learners to benefit from the mental discipline and the intellectual development that results from its study (Asi et al, 2015). Language was viewed as an academic discipline rather than as a means for conducting everyday social interaction. The Grammar Translation Method was broadly construed, as a way of studying language through detail analysis of its grammar rules. This was followed by the application of this knowledge to the task sentences and text, into and out of the target language (Richards and Rodgers, 1986).

The ability to carry out translation was underpinned by the mastery of grammar system. The primary skills to be developed are reading and writing. Little attention is given to listening and speaking. In this method, grammar is taught deductively; grammar rules are presented with examples. Vocabulary selection is based solely on the reading text used. Words are taught through a bilingual word list, dictionary study and memorization (Austin J.D., 2008). The students are given a list of target language vocabulary words and their L1 equivalence and they have to memorize them. They are also required to memorize grammatical rules.

Translation is an important tool especially in EFL environment (Ellis, 1992) Grammar and vocabulary items are presented with translation equivalence and translation exercises. There is the translation of the reading passages from the target language into the L1. Comprehension is achieved through translation from the target language into the mother tongue Translation in foreign language learning process promotes understanding. The Grammar Translation Method has been considered useful for students in second language acquisition in that it enriches one's vocabulary, increases the number of figures of speech one can use, develops the ability of interpretation and through the imitation of the best writers it makes us able to produce similarly good texts, because translation forces us to notice such details as would escape the attention of a simple reader (Hell, 2009 cited in Mart, 2013). However, the grammar translation has its shortcomings. The teacher is the authority while the students are passive and most of the interaction in the classroom is from the teacher to the students. There is little student initiation and interaction. In addition, there was a tedious experience endless lists of unusable rules of grammar and vocabulary items (Asi et al, 2015).

## **2.2. The Direct Method**

The limited practicability of the Grammar Translation Method for communicating in everyday situation created dissatisfaction toward the end of the 19th century among language teachers in Europe. The need for a more scientific approach to language learning and teaching led to the expounding of the Direct Method. It is premised on the belief that as with first language learning, total immersion in the target language is conclusive to rapid progress in communication (Richard and Rodgers, 1986). The teacher's role is to provide contextual support for learners without recourse to the learner's mother tongue as far as possible. The purpose of language learning is communication. Listening and speaking skills precede reading and writing. Grammar learning is inductive and restricted to forms that are commonly used in the spoken language. The teacher should demonstrate not explain or translate so that students can make a direct association between the target language form and meaning. Thus, objects present in the immediate classroom environment should be used to help students understand meaning (Lestari and Rahmi, 2011). Vocabulary is acquired naturally through sentence construction. Hence, objects like realia, pictures, or pantomime are used to help students understand the meaning of a language point or vocabulary item. The students should be encouraged to speak as much as possible. Also, the classroom should involve some

conversational activities such as dialogue, role play, debates, and question and answer exercise which gives students the opportunity to use language in real context.

The major fallacy of the Direct Method was the belief that second language should be acquired in the way in which the first was acquired. Nevertheless the two contexts are not similar thus the method of acquisition cannot be the same (William L., 2013).

### **2.3. The Audio-lingual Method**

The emergence of the Audio-lingual Method resulted from the increase attention given to foreign language teaching in the United States in the 1950s. The objective of the Audiolingual Method is for learners to attain conversational proficiency in a foreign language (Harmer, 2001). Thus, teachers were expected to provide students with a native speaker-like model in order for students to mimic the model. Here, language learning is a process of habit formation. The more often something is repeated the stronger the habit and the greater the learning. New vocabulary and structures are presented through dialogues to create a context. The dialogues are learnt through repetition and imitation. Drills such as repetition, substitution, transformation and questions and answer are conducted based upon the pattern presented in the dialogue. A dialogue or a short conversation between two people is often used to begin a new lesson and students memorize the dialogue through mimicry. The use of visual aids has proven its effectiveness in vocabulary teaching (Richard and Rodgers, 1986). The audiolingual method makes language teaching possible to large groups of learners. However, teachers' domination of the class led to boredom caused by endless pattern drills. Students lacked active role in the classroom (Allen et al, 1972). The synthesis of behaviourism and structural linguistics in the Audiolingual Method was criticized.

### **2.4. The Communicative Language Teaching (CLT)**

The CLT is an approach that saw the light of day during the 1970s, when there was need for new techniques to meet learners' needs. Language teaching experienced a shift from Situational Language Teaching which was the major British approach to teaching English as a foreign language to CLT (Brown, 2001). The language theory behind the communicative language teaching is very rich and somehow eclectic. The primary function of language is for interaction and communication and the goal of language teaching is to develop the communicative competence (Ibid). Hymes' (1972 cited in Richard and Rodgers, 1998) definition of communicative competence is what a speaker needs to know in order to be

communicatively competent in a speech community. Savignon, (1983) notes that communicative competence is: “our ability to convey and interpret messages and to negotiate meanings interpersonally within specific contexts”. Another linguistic theory of communication favored in the CLT is Halliday’s (1970) functional account of language use. The goal of the CLT is to achieve communicative competence and to develop procedures for the teaching of the four language skills that acknowledge the interdependence of language communication (Richard and Rodgers, 1998). Littlewood (1981) states, “one of the most characteristic features of communicative language teaching is that it pays systematic attention to functional as well as structural aspects of language”

In the CLT, the teacher assumes the role of a facilitator of the learning process and a guide within the classroom procedures and activities. The teacher has the responsibility to determine and respond to learners’ language needs. He/she carries out research and organizes resources to suit learners’ level and needs (Breen and Candlin, 1980). Learners on the other hand, assume the role of a negotiator between the self, the learning process, and the object of learning. The implication is that the learner should contribute as much as he/she gains and thereby, learns in an interdependent way (Ibid).

Often, there is no text, grammar rules are not presented; classroom arrangement is nonstandard and students are expected to interact primarily with each other rather than with the teacher. Correction of errors may be absent or frequent. The instructional materials used to promote communicative language use are the following: games, role plays, simulations and realia such as signs, magazines, advertisements, newspapers, visual sources. Communicative competence implies knowledge of the grammatical system of the language as well as performance. The semantic content is given the priority in language learning. Learners acquire the grammar through meaning. CLT follows a systematic learning process involving trial and error. Errors are considered inevitable and predictable in the process of language learning. The teacher should be tolerant and need not correct every mistake (selective error correction). Fluency is emphasized rather than accuracy. The CLT is a learner-centered approach which gives learners the opportunity to contribute to their learning. More important, the class should be held in the target language to permit the learners to communicate. It is important to note that Savignon (1972) however, rejects the notion that learners must first gain control over individual skills (pronunciation, grammar, vocabulary). Then, can they apply them in communicative tasks. She advocates that the communicative practice be provided from the start of instruction.

### 3. Competency Based Approach

#### 3.1. A brief Background History of the CBA

Although there are not many records on the history of the CBA, some argued that its theoretical foundation lies in the behaviorist models of human psychology. This is based on the view that the CBA is about making inferences about competency on the basis of performance (Chelli, 2010). It can also be initially traced back to the scientific management theory of Taylor (1947) in which he elevated the work place into a science. He was the first who found the CBA and tested it. However, it has been argued that the CBA was first utilized in the military field in the late 1960s in the United States of America, and then it was developed into professional educational programs. Moreover, it was introduced in the form of vocational training programs in the United Kingdom and Germany in the 1970s, and vocational training and professional skills recognition in Australia in the 1990s (Bowden, 1993).

The history of competence-based curriculum can be traced back to the early 1970s when competence-based education emerged for the first time in the United States of America (Richard & Rogers, 2001). It is an educational movement that defines educational goals in terms of precise measurable descriptions of knowledge, skills, and behaviors students had to possess at the end of the course of study. Thereafter, the movement spread into European countries such as the United Kingdom and Germany in the 1980s (Wolf, 2001).

Other countries worldwide have been motivated to implement the competence-based curriculum in schools due to the ever-changing technology and global market. In Africa, competence-based curriculum was adopted for the first time in South Africa in 1998, following the acute shortage of professionals like engineers, technicians and artisans. South Africa adopted the competence-based curriculum in a bid to change attitudes of all South Africans and equip them with employable skills to cope with challenging issues in the 21st century.

The competency-based approach (CBA) as stated by Richards and Rodgers (2001) adheres to the interactional and functional views of language learning; it advocates the determination of learning goals in terms of measurable and precise descriptions of knowledge, skills and behaviors, expected from the part of learners at the end of a course of study. In like manner, Bowden (2004) asserts that determining outcomes in explicit and precise ways are prerequisites for a successful career. Emphasis on observable behaviors goes back to the origins of CBA which, as stated by Tuxworth (1990), drew on industrial and business models

that specified outcomes in terms of behavioral objectives. Similarly, Richards (2006) views that work related and survival oriented language teaching relied widely on the competency-based model, so as to teach students the basic skills they need for every day survival situations. For Docking (1994), a CBA is:

*(...). Organized not around the notion of subject knowledge but around the notion of competency. The focus moves from what students know about language to what they can do with it. The focus on competencies or learning outcomes underpins the curriculum framework and syllabus specification, teaching strategies, assessment and reporting. (p.16)*

Accordingly, CBA is stressing what learners can do with language, not what they know about language. The curriculum, the syllabus, the teaching strategies and assessment tools are organized around competency development rather than language knowledge. Within this scope, Aurebach (1986) lists eight key features of the CBA

1. A focus on successful functioning in society: The goal is to enable students to become autonomous individuals capable of coping with the demands of the world.
2. A focus on life skills: Rather than teaching language in isolation, CBA/ESL teaches language as a function of communication about concrete tasks. Students are taught just those skills required by the situations in which they will function.
3. Task-or performance-centered orientation: What counts is what students can do as a result of instruction. The emphasis is on overt behaviors rather than on knowledge or the ability to talk about language and skills.
4. Modularized instruction: Objectives are broken into narrowly focused sub objectives so that both teachers and students can get a clear sense of progress.
5. Outcomes which are made explicit a priori: Outcomes are public knowledge, known and agreed upon by both learner and teacher. They are specified in terms of behavioral objectives so that students know exactly what behaviors are expected of them.
6. Continuous and ongoing assessment: Students are pretested to determine what skills they lack and post tested after instruction in that skill. If they do not achieve the desired level of mastery, they continue to work on the objective and are retested. Program evaluation is based on test results and, as such, is considered objectively quantifiable.
7. Demonstrated mastery of performance objectives: Rather than the traditional paper- - and- pencil tests, assessment is based on the ability to demonstrate pre-specified behaviors.



8. Individualized, student-centered instruction: In context, level, and pace, objectives are defined in terms of individual needs; prior learning and achievement are taken into account in developing curricula. Instruction is not time-based; students progress at their own rates and concentrate on just those areas in which they lack competence (414-415).

Weddel (2006) summarizes the different stages of CBA pedagogy into; first, an assessment of the learners needs, second a selection of the competencies that should be specific and stated in measurable behaviors. Third, determination of the target instruction; the content is based on learners' goals i.e. competencies. Last but not least evaluation of the competency, learners continue to learn until mastery of the competency. Assessment should be criterion-referenced: each competency must have clear performance criteria, and learners need to be assessed on how successful they are in performing tasks, not how well they know about language.

### **3.2. Difference between Competence and Competency**

Throughout the last two decades, the discourse around education and training has shifted toward the use a pseudo-commercial language of investment, markets, and products. The focus on competence and competency has been part of this move. These two terms are still difficult to be described satisfactorily (Chelli, 2010).

#### **3.2.1. Definition of Competence**

Competence is frequently considered as an important concept in order to learn any FL. The term Competence was defined in the New Oxford Advanced Learner's Dictionary (2005) as "the ability to do something well" (p.294). Likewise, in the Business Dictionary, it was defined as a cluster of related abilities, commitments, knowledge and skills that enable a person (or an organization) to act effectively in a job or a situation. In this sense, competence indicates sufficiency of skills and knowledge that enable one to perform in a given context successfully. Besides, the term competence focuses attention on learning outcomes. It is what people can do. It involves both the ability to perform in a given context and the capacity to transfer knowledge (Harris, Guthrie, Horbat, & Lundberg, 1995). It means that, competence focuses more on outcomes rather than the process. According to Definition and Selection of Competence (DeSeCo) (2002), the term competence was described as "a system of internal and external mental structures and abilities assuming mobilization of knowledge, cognitive skills and social behavioral components such as attitudes, emotions for successful realization of activity in particular context"(p.7). In this respect, competence can be comprehended as the ability to accomplish a task or an activity

successfully in a given situations. In like manner, it was described simply by Knouwenhaven (2012) as “the capacity to accomplish’ up to standard’ the key occupational tasks that characterize a profession” (p.126). On the basis of the various definitions, it can be understood that competence is both a physical and an intellectual ability to acquire something well through training or experience.

### 3.2.2. Definition of Competency

The term Competency was described by numerous researchers in the literature from different points of view. Docking (1994) presented a comprehensive definition of competency, according to him:

An element of competency can be defined as any attribute of an individual that contributes to the successful performance of a task, job, function, or activity in academic setting and/or a work setting. This includes specific knowledge, thinking processes, attitudes, and perceptual and physical skills. (as cited in Richards & Rodgers, 2001, p.145)

Therefore, competency might be a task, a role, a function which changes over time, and will vary from context to another. According to Hedges (1996) a competency is “a skill or characteristic of a person which enables him or her to carry out specific or superior actions at a superior level of performance” (as cited in Hyde, 1996, p.4). However, we can say that competency is not the same as performance, but rather is the capacity that empowers performance to take place.

Additionally, different definitions have been suggested in the field of education, for example, the term competency was described by Québec Education Programme (2001) as:

A set of behaviors based on the effective mobilization of a range of resources. The set of behaviors refers to the capacity to use appropriately a variety of resources both internal and external in particular learning acquired in school or in everyday life. The concept of resources refers not only to everything that students have learned at school, but also to their experiences, skills, interests...ect. students may rely on many resources, such as their classmates, their teacher, documentation. (p.4)

Another definition among many others has been given by ELT articles “Introducing the CBA”( 2009) which consider competency as “a system of conceptual and procedural parts of knowledge organized into schemes that help identify a problem task and its solution through an efficient action within a set of situation” (p.1). That is to say, a competency is the ability of a student or an individual to accomplish tasks adequately, to find solutions, and realize them

in real life situations. On the premise of all these definitions it can be comprehended that the concept competency involves being good at doing something.

All in all, competence refers to the ability or capability of an individual to accomplish a task or an activity in a given situation effectively, whereas, competency refers to actual performance of an individual in a situation. This means that, competence describes what people do while competency focuses on how they do it.

### 3.3. Definition of the CBA

The CBA is a very popular approach which focuses on measurable and useable knowledge, skills and abilities. It consists of teachers basing their instructions on concepts expecting to foster deeper and broader understanding (Chelli, 2010). It has been also defined by Richards and Rodgers (2001) as “an educational movement that focuses on the outcomes or outputs of learning in the development of language program. CBA address what learners are expected to do rather than on what they are expected to learn about. In addition, Savage claimed that the CBA is” a functional approach to education that emphasizes life skills and evaluates mastery of those skills according to actual learner performance” (1993, p. 15). In like manner, Scheck (1978) argued that the notion of CBA can be defined as “an outcome-based instruction that is adaptive to the changing needs of students, teachers, and the community”(p.5).By means, competencies describe the student’s ability to apply basic and other skills in situations that are commonly encountered in everyday life. Thus the CBA is based on a set of outcomes that are derived from an analysis of tasks typically required of students in life role situations.

In sum, this new approach depends on improving students' competencies in order to help them to face some issues in their everyday lives. It intends to enable students to put what they have realized in other life settings. In other words, the CBA came to empower learners to be more autonomous individuals in their school life settings as well as in real life settings.

Implementing the CBA is an important issue in the Algerian education system since most of the teachers mainly the novice ones are unaware of its principles. Therefore, it is worth presenting this approach. Many researchers seek to facilitate and to explain this educational change; for instance, Richards and Rodgers (2002) define this new approach as "an educational movement that focuses on the outcomes or outputs of learning in the development of language programs. CBE address what the learners are expected to do with the language.

However they learned to do it. The focus on outputs rather than on inputs to learning is central to the competencies perspective " (p. 141). In addition, the U.S. Office Education (1978) defines CBE as a functional approach that focuses on life skills and evaluates those skills according to learner performance (Savage, 1993; cited in Kathleen, 2006) .

As a conclusion, this new approach is based on developing learners' competencies in order to help them to face some problems in their daily life. It aims to enable learners to put what they have learned in other life settings. For that reason, the CBA come to relate the tow settings: school life and real life setting, to help learners become competent in their society.

### **3.4. Characteristics of the CBA**

The first apparent characteristic of the CBA is the focus on learning and pupils' activities (learners' centered) rather than on the teacher's role. The CBA is socio-constructivist approach based on training students to construct their own knowledge to be able to use it in the daily life. According to Auerbach (1986) the essential features that are included in implementing the CBA syllabus are:

- A focus on successful functioning in society. The goal is to enable students to become autonomous individuals capable of coping with the demands of the world.
- A focus on life skills rather than teaching language in isolation, the CBA teaches language as a function of communication about concrete tasks. In other words, the CBA is not only interest in teaching language but also teaching a function of communication in real life.
- It is a task or performance-oriented orientation. The focus of the CBA is on clear behaviors rather than on knowledge or the ability to talk about language and skills.
- Outcomes that are made explicit a prior. Outcomes are recognized and decided by both learners and the teacher.
- Continuous and ongoing assessment which means that learners are tested before the course to determine which skills they lack and after they have had instructions in that skills they tested again to ascertain whether they have achieved the necessary skills or not. That is to say the program evaluation of the CBA is based on test results in which learners continue learning until mastery is demonstrated.
- Individualized, student-centered instruction. The instruction given by the teacher is not time-based but the focus on the progress the individual learners make at their own

rate. Therefore, according to the content, level, and space, objectives of the lessons are stated via individual requirements.

In addition to these characteristics, the ELT Articles, what is CBA, 2008 suggested that the CBA is characterized by the following:

- The CBA is action- oriented in that it gears learning to the acquisition of know how to embedded in functions and skills. These will allow learners to become effective competent users of a FL in real life situations outside the classroom.
- It is a problem-solving approach in that it places learners in situations that test/check their capacities to overcome obstacles and problems; make learners think and learn by doing.
- It is social constructivist approach in that it regards learning as occurring through social interaction with other people. In other words, it is an approach which is based on training learners to construct their own knowledge to be able to use it in the daily life.
- Finally, and most importantly, the CBA is a learned-centered approach which focuses on the learners' role rather than the teacher role.

### **3.5. Principles of the CBA**

From the abovementioned characteristics, it is noticed that the principles of the CBA are divided into two sections, principles that have a relation with a learner and principles which concerned a teacher. The ELT Articles, introducing the CBA, 2009 suggested the following principles:

#### **3.5.1. Principles Concerning the Learner**

- The learner should be motivated and creative.
- Learners see each other as resources (turned for each other to for help).
- Learners can make some decisions (regarding homework, subject matter...).
- Learners ask questions and give answers of their own initiative.
- Learners use English in the classroom more than the teacher.
- Learners can summarize material acquired through research.
- Learners must be aware of the strategies they can use to learn better.
- Learners are not afraid of making errors and viewed them as learning opportunities.
- Learners can work together to have the spirit group and learn from each other.

### 3.5.2. Principles Concerning the Teacher

- The teacher allows time for learners to think.
- The teacher encourages learners to derive language patterns and rules.
- The teacher uses a variety of activities to address different learning styles.
- The teacher asks learners how they got the answer and did not accept just the answer.
- The teacher plans the task, monitors the work but without destroying it.

### 3.5.3. Components of the CBA

The CBA consists of the four components which are proposed by Weddel in (2006, p.3) as the following:

- a. An assessment of the learner's needs.
- b. The selection of the competencies.
- c. The target instruction.
- d. An evaluation of the competency attainment.

Learners continue to learn until mastery of the competency. Assessment should be criterion-referenced: each competency must have clear performance criteria, and learners need to be assessed on how successful they are in performing tasks, not how well they know about language.

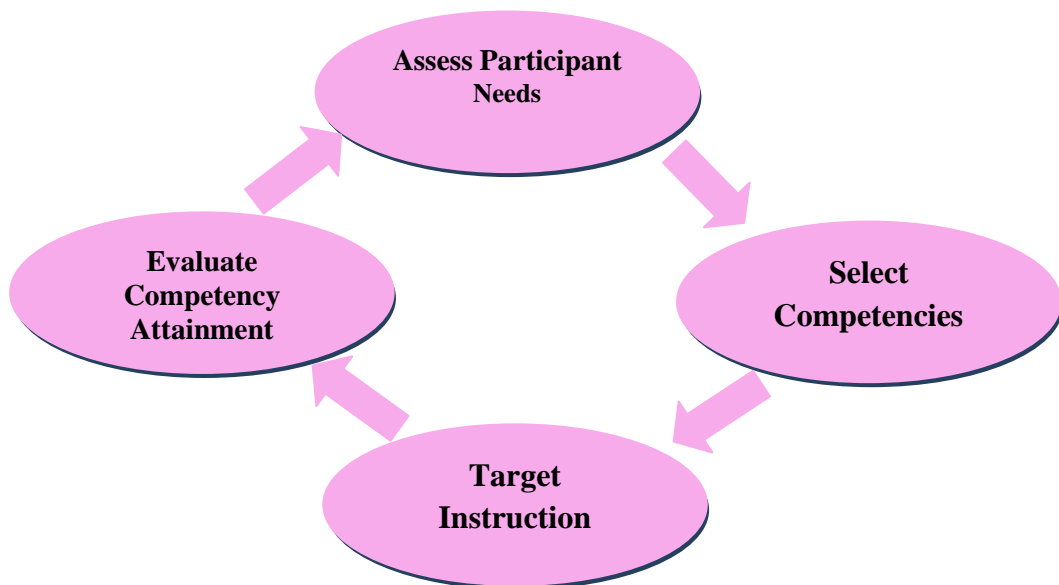

**Figure 1: Components of the CBA (Weddel, 2006)**

From (Figure 1) above, we can see that the CBA is a cyclical approach. Since its four components do not work in isolation, because the approach begins with the assessment of student's needs, moves toward the selection of the expected competencies, then to the target

instruction, and finally moves to the evaluation of the rate of attainment of the competence and returns back to the assessment of needs.(Nkwetisama, 2012)

### **3.6. The learner' role in the CBA**

The learner is active and learns to learn by acting upon his learning; he is at the heart of this instruction. Richards and Rodgers (2001) advance that the learner needs to practice and perform the skills taught; he has to do something with the language, not just knowing about the language. He is required to be well aware of the appropriate and purposeful uses of the targeted competencies. Moreover, he must be able to transfer the knowledge gained in school to pertinent contexts of use outside, in real life. Mastery of the stated competency determines the learner's success. If the specified competency is unattained he stays in the actual program.

The CBA focuses on the learner's role rather than on the teacher's role. The learner plays the central element inside the classroom that learns through a series of activities that are proposed by the teacher. Therefore, learners in the CBA are characterized as active persons who can search to develop themselves and make self assessment in order to be successful learners (Chelli, 2010). Thus, they will be able to face problems in their daily life. Moreover, the main goal of the learner in the CBA is to be able to adopt and transfer knowledge from one setting to another (Richards & Rodgers, 2001). Additionally, learners must be willing to challenge, to question, and to interact in the CBA classroom (Marcellion, 2005). Finally, since the CBA is learned- centered, learners are no more passive receivers of knowledge; they play an active rather than a reactive role in the learning process and are required to construct and mobilize their resources to face with efficacy problem situation (Chelli, 2010).

### **3.7. The Teacher' role in the CBA**

The teacher's role under the CBA changes from one of being an information-giver to that of facilitator. That is to say, the teacher is no more just a transmitter of knowledge, but rather is assigned the role of facilitator who engages learners in tasks, and helps them develop learning strategies for an effective learning (Chelli, 2010). Additionally, the teacher is a counselor in that s/he exemplifies "an effective communicator seeking to maximize the meshing of speaker intention and hearer interpretation, through the use of paraphrase, confirmation and feedback" (Richards & Rodgers, 2001, p. 78). Furthermore, the teacher has to provide positive and constructive feedback in order to help learners to improve their skills (Harmer, 2001). The teacher is also required to be a researcher and a

learner especially in how projects are realized and what requirements need to be met for the accomplishment of those projects (Richards & Rodgers, 2001). Another role of the teacher in the CBA is to select learning activities and design syllabus according to the competency the learners are going to acquire (Richards & Rodgers, 2001). In short, the teachers' role under the CBA is a facilitator who helps learners to be responsible for their learning.

Teachers under a learner-centered approach, that is the CBA, are no more the detainers of knowledge, but facilitators and guides; they assist their learners all along the path toward competency acquisition. Still, they have to determine what and how well learners must perform; they give clear instructions and make sure that every learner understands the task. In this respect, Paul (2008) maintains that teachers need to be providers of authentic materials, activities, and practice opportunities. Those materials, as advanced by Griffith and Lim (2014), need to be oriented toward doing rather than knowing, and related to any domain of life. Typical areas, for which competency-based activities can be suggested, can involve job interview or job application; These areas are described by Docking (1994) '...as a collection of units of competencies' which consist of 'specific knowledge, thinking processes, attitudes, and perceptual and physical skills' (14); the competency specified needs to be dissected into sub skills that call upon a specific knowledge, skills and attitudes. Teachers need to guarantee an individualized instruction, as learners are supposed to move at their own paces; instruction is not time-based. They are also required to provide constructive feedback on how well learners are doing toward successful completion of tasks; they have to ensure an ongoing assessment.

The common role of the teacher under the Competency Based Approach is the role of facilitator. In this context Dobson (2003) claims that Facilitator he is "a person who helps learners learn by discovering things for themselves" (p. 64).

According to Harmer (2001) the role of the teacher changes according to the task, and an effective teacher knows how to choose the relevant role in the appropriate position, and he further said that the role of facilitator is wide in meaning. Thus, he suggested a set of precise roles that go in harmony with the term facilitator (p. 57).

**Controller:** when teacher act as controller he expected act in different way in comparison to his role in the state where students are working in group (ibid, 2001, p. 58).



(Davies and Pearse ,2000) add some explanations about this role. He said that he transmits information, controls occurrence of activities from the front, motivates to participate in the class with the correction of errors (p. 127).

**Organizer:** "The teacher has to initiate students to collaboration through pair and group work " (Bader, 2007, p. 47). The teacher has to organize students in pair or in group .He has to initiate, to explain the content of activities, and end tasks when time is finished (Harmer, 2001, p. 58).

**Assessor:** Dobson (2003) thinks that "the Assessor A person qualified to carry out assessment" (p. 62). Therefore, his role is to give feedback, correction, and grading to their students (Harmer, 2001, p. 59). He also informs the learners about their progress, trying to combine encouragement with honest evaluation and useful feedback (Davies & Pearse, 2000, p. 127).

**Prompter:** "Prompter could refer to the teacher's role in helping a student to remember and formulate a point" (Hedge, 2000, p. 29). Prompter supply students with a clarification question or information when they could no longer follow what are doing (Harmer, 2001, p. 60).

**Participant:** Sometime the teacher chooses sharing his students some activities. When it goes well, students feel satisfied (ibid, 2001, p. 61).

**Resource:** "Person who provides students with materials beyond the textbook" (Dubin & Olshtain, 1986, p.48). According to Harmer (2001) Teacher source guides his students to look for information instead of providing them with the desired information (p. 61).

**Tutor:** Teacher behave as tutor when he approach from his students in more personal contact ,thus the student feel supported and helped from their teacher. This usually occurs when students organized in group and the teacher work with individuals and small group (ibid, 2001, p. 62).

**Observer :**The teacher expects to use his ability to observe and listen to his students (Chelli, 2010, p. 26). In order to help the teacher to respect the learning styles of his students and to select to them the appropriate activities (Dubin & Olshtain, 1986, p. 48). We can infer that this entire role fit the application of competency-based approach in teaching writing, since it

help learner in realize autonomy learning ,and the teacher in this state only help the ongoing of the learning process.

#### **4. The CBA in the Algerian Primary School**

The introduction of English in primary education (third grade) as from the school year 2022-2023 has been a challenge the State has taken to allow pupils learning this universal language. When Algerian children went back to primary school for their third year on 21 September 2022, they discovered a disconcerting change of program. For in addition to French, which they start learning at that point in their school curriculum – *age 08 or 09* – they will start studying a second foreign language, English. The decision to start teaching English in primary schools this year brought sceptical reactions from educationalists, teachers' unions and politicians. According to the inspector of English, Algerian primary teachers have been called upon to teach through competency-based approach (CBA); they have mostly relied on the guidelines outlined in the textbooks and syllabuses to apply the principles of this new pedagogy.

#### **Conclusion**

This chapter accounted for the concept of competency-based approach by exploring its concepts, the main methods and how it was implemented, it concluded by a description of the CBA in the Algerian primary schools. The next chapter will present general definitions and terms related to the pupil's comprehension abilities.

## Pupils' Comprehension Ability

### Introduction

This second chapter sheds some lights on a general overview of English comprehension abilities the chapter offers definitions of comprehension abilities, also deals with the types of tasks and activities in the classroom then the use of materials in the classroom. In addition to that, in this chapter, there exist lesson planning, textbook of 3rd year primary school, topics and communicative objectives and the role of the textbook in the classroom the current chapter ends with the evaluation under the CBA.

### 1. Definition of Comprehension

Comprehension actually comes from the Latin term, *comprehensionem*, which means "a seizing." When you have comprehension of a subject, you have seized information and incorporated it into your own knowledge. Any kind of mental grasping of an idea or a subject is a kind of comprehension. (vocabulary.com dictionary).

Comprehension is the ability to understand the meaning or importance of something (or the knowledge acquired as a result). The ability to understand completely and be familiar with a situation, facts, etc.(Cambridge dictionary)

Comprehension is the ability to understand something. Comprehension is full knowledge and understanding of the meaning of something. When pupils do comprehension, they do an exercise to find out how well they understand a piece of spoken or written language. (Collins dictionary).

### 2. Comprehension Abilities

#### 2.1. Reading

According to Brown (2004, p189), reading is a process of negotiating meaning to the texts for understanding. In the case, reading is a way or process to gain information from a text. Reading consists of two related processes: word recognition and comprehension. Word recognition refers to the process of perceiving how written symbol correspond to one's spoken language. Comprehension is the process of making sense of word, sentence and connected text. It is appropriate with McNamara (2007, p28) who states that comprehension is the interpretation of the information in the text, the use of prior knowledge to interpret this information and ultimately, the construction of a coherent representation or picture in the reader's mind of what the text is about.

Based on Klingner (2007, p02) reading comprehension is the process of constructing meaning by coordinating a number of difficult processes that consist of word reading, word and world knowledge, and fluency. From the declaration above, it can be concluded that reading comprehension is a kind of skill in reading which make the readers can create meaning from written text which make them able to understand the information in it.

McNamara (2007, p03) states that reading is an extraordinary achievement when one considers the number of levels and components that must be mastered. It means that when the reader read, the reader must understand and master some components of the text. According to Grellet (1981, p07), reading is a constant process of guessing and what one brings to the text is often more important than what one finds in it. There are many symbols and writings that must be known in the text that is read. This is why, from the very beginning, the students should be taught to use what they know to understand unknown elements, whether these are ideas or simple words. Therefore, reading is the key to successful language learning, especially in foreign language. By reading the reader can get information about knowledge of technology and science.

Comprehension entails three elements; the reader who is performing the comprehending, the text which is to be comprehended, and the activity in which comprehension is a part. Furthermore, these three elements will influence each other in order to create a good comprehension for students or readers. Klingner (2007, p08) explains that reading comprehension is multicomponent, highly complex process that involves many interactions between readers and what readers bring to the text (previous knowledge, strategy use) as well as variables related to the text itself (interest in text, understanding of text types). Similarly, McNamara (2007, p111) says that reading comprehension is a product of complex interactions between the properties of the text and what readers bring to the reading situation.

## **2.2. Writing**

Nunan (2003, p88) states that writing is an intellectual activity of finding the ideas and thinking about the way to express and arrange them into a statement and paragraph that is clear to be understood by the people. It indicates that the writers are demanded to show the thoughts and organize them into a good composition. In addition, writing presents the writer's concept in understanding an issue which is shown to the public. It requires the integration of idea systematically written. Writing is considered as an active creation of text involves on the one hand lower-order transcription skills such as handwriting, punctuation and spelling, and on the other hand, higher-order self-regulated thinking processes such as planning, sequencing

and expressing the content (Berninger et al, 2002). It requires the writer to express the content of writing into a good composition by considering the aspects of writing to be understood by the readers. According to White and Arndt (1991) in Hammad (2013, p01), writing is a thinking process which demands intellectual effort, and it involves generating ideas, planning, goal setting, monitoring, evaluating what is going to be written as well as what has been written, and using language for expressing exact meanings. It means that writing consists of some stages that should be done by the writer in conveying the message of writing.

### 2.3. Listening

Listening has been defined by many researchers. Thomlison (1984) and Hamouda (2013) defined listening as the ability to recognize and understand what others are telling. This process includes understanding a speaker's pronunciation, the speaker's grammar and vocabulary, and understanding of meaning. Morley (1972) said listening involves auditory discrimination, aural grammar, selecting necessary information, remembering it, and connecting it to the process between sound and form of meaning (as cited in Pourhosein Gilakjani & Sabouri, 2016).

According to Krashen (1985) and Hamouda (2013), listening skill is an important element in obtaining understandable input. Learning will not occur if there isn't any input. Hasan (2000) and Hamouda (2013) expressed that listening comprehension provides the appropriate situations for the acquisition and expansion of other language skills. Rost (2002) expressed that the development of listening is related to the attainment of proficiency in speaking. He continued that listening is the most important skill in language learning because it is the most widely used language skill in normal daily life.

Bowen, Madsen, and Hilferty (1985) demonstrated that listening is understanding the oral language. Students hear oral speech, divide sounds, classify them into lexical and syntactic units, and comprehend the message (as cited in Pourhosein Gilakjani & Sabouri, 2016). Listening is a process of receiving what the speaker says, making and showing meaning, negotiating meaning with the speaker and answering, and creating meaning by participation, creativity, and empathy. Listening is a complex process of interpretation in which listeners match what they hear with what they already know (Rost, 2002 as cited in Pourhosein Gilakjani & Sabouri, 2016).

According to Goss (1982), listening is a process of understanding what is heard and organizing it into lexical elements to which meaning can be allocated (as cited in Pourhosein

Gilakjani & Sabouri, 2016). According to Purdy (1997), listening is the process of receiving, making meaning from, and answering to spoken and/or nonverbal messages. Rost (2009) told that listening is an active and important mental ability. It aids us to understand the world around us and is one of the necessary elements in creating successful communication (as cited in Pourhosein Gilakjani & Sabouri, 2016).

According to Pourhosein Gilakjani and Ahmadi (2011), listening plays a significant role in the communication process. Ferris (1998), Murphy (1991), Vogely (1998), and Hamouda (2013) expressed that listening is the most frequently used skill in the language classrooms. Therefore, it is obvious that listening is very important for the lives of students since it is used as a means of learning at all phases of instruction. Despite its significance in foreign language learning, the instruction of listening comprehension has been overlooked in many EFL classes. According to Oxford (1990), listening develops faster than the three other language skills and it can make easy the development of the other language skills.

Listening skill is very important in foreign language learning because the key to learn a language is to receive language input. According to Krashen, Terrell, Ehrman, and Herzog (1984) and Hamouda (2013) acquisition happens when learners have sufficient comprehensible input. Rost (1994) stated that listening is significant in language learning because it provides input for learners and it plays an important role in the development of learners' language.

### **2.3.1. Listening comprehension**

There have been different definitions of the term "listening comprehension." Rost (2002) and Hamouda (2013) defined listening comprehension as an interactive process in which listeners are involved in constructing meaning. Listeners comprehend the oral input through sound discrimination, previous knowledge, grammatical structures, stress and intonation, and the other linguistic or non-linguistic clues (as cited in Pourhosein Gilakjani & Sabouri, 2016).

Nadig (2013) defined listening comprehension as the various processes of understanding and making sense of spoken language. These involve knowing speech sounds, comprehending the meaning of individual words, and understanding the syntax of sentences (as cited in Pourhosein Gilakjani & Sabouri, 2016). According to Brown and Yule (1983) and Hamouda (2013), listening comprehension is an individual understanding of what he has heard and it is

the listener's ability to repeat the text despite the fact that the listener may repeat the sound without real comprehension.

According to Bouach (2010), listening comprehension is useful for learners' pronunciation. That is, when learners are more exposed to spoken English, they can more know and get used to its pitch, intonation, stress, redundancy, and clusters. Wilson (2008) mentioned some other reasons for listening such as information gathering, enjoyment, unanimity, evaluation, and criticism. In addition, the other reason behind listening is to improve the speaking skill by improving pronunciation.

Listening comprehension process provides beneficial intuitions in teaching listening. Learner may find listening comprehension skill difficult to learn and this can also provide teachers with opportunities to change their listening exercises into more effective ones. Developing listening comprehension skill helps learners to succeed in language learning to enhance comprehensible input. Since learners' self-reliance in listening comprehension will be increased, they will be motivated to have access to spoken English such as conversations with native speakers (Kurita, 2012).

There are a lot of reasons for listening. There are five main reasons for listening like to engage in social protocols, to exchange information, to enjoy yourself, to share emotions, and to exert control (Hedge 2000). Underwood (1989) expressed that teachers should prepare their students for the following situations:

- Attending a lesson. The purpose of this activity is to comprehend the major ideas and to recognize the main information.
- Listening to announcements, news, and weather forecast. The main goal of listeners is to obtain pertinent information.
- Listening to plays, watching TV, or listening to a radio for entertainment. The objective of this activity is to amuse oneself.
- Listening to someone delivering a speech. In this situation, the listener is interested in opinions and attitudes of the speaker.
- Following the instructions. The goal of the listener is to perform the function successfully.

### 2.3.2. The importance of listening

Listening comprehension needs more concentration and a quick understanding is also required. When listening, a lot of factors should be specifically paid attention. They are context, facial expressions, and body gestures that are very important for the listeners to facilitate the understanding of what is conveyed by speakers (Ziane, 2011).

According to Rost (1994) and Ziane (2011), listening comprehension is very important because it is a process through which we get input and without its comprehension learning does not happen. Doff (1995) and Ziane (2011) represented that listening has a significant effect on developing speaking. That is, we cannot develop our speaking ability unless we develop our listening skill. If a learner has a good listening ability in English language, it would be very easy for him to listen to the radio, to study, watch films, or communicate with foreigners. Learners should have a lot of practice and exposure to English in order to develop this ability. There is a relationship between listening to a language and learning it. If we compare two learners; one is living in a country where the target language is the first language and the other is living in a country where English is only spoken in academic places. The difference is that the first learner can acquire English more easily, effectively, and rapidly than the second one. Consequently, learners need as much exposure to English language as possible.

According to Hedge (2000), listening has an important role in everyday life and when people are engaged in communication nine percent is spent to writing, 16 percent to reading, 30 percent to speaking, and 45 percent to listening which shows the significance of listening in the communication process. Lundsteen (1979) expressed that listening is the first skill to appear. He continued that children listen before they speak. Hedge (2000) indicated that modern society likes to change from printed media towards sound and its members. Therefore, the significance of listening cannot be ignored. He emphasized that listening is of great importance in English language classrooms.

### 2.4. Speaking

Speaking among the other foreign language skills (listening, reading and writing) seems intuitively the most important one. As the process of learning and applying the skills of oral English are so closely related, classroom should be a place where the use of spoken language is sensitively supported since it enables students to make connections between what



they know and what they are learning, and it is the one through which they are going to be judged while the first impressions are being formed, that's why according to (Ur, 1984, p120):

"Many if not most foreign language learners are interested in learning to speak"

Speaking is "the process of building and sharing meaning through the use of verbal and non-verbal symbols, in a variety of contexts" (Chaney, 1998, p. 13) Speaking is an interactive process of constructing meaning that involves producing and receiving and processing information (Brown, 1994; Burns & Joyce, 1997). Speaking is a crucial part of second language learning and teaching. Despite its importance, for many years, teaching speaking has been undervalued and English language teachers have continued to teach speaking just as a repetition of drills or memorization of dialogues. However, today's world requires that the goal of teaching speaking should improve students' communicative skills, because, only in that way, students can express themselves and learn how to follow the social and cultural rules appropriate in each communicative circumstance, therefore recent pedagogical research on teaching students conversation has provided some parameters for developing objectives and techniques. Similar to listening, speaking is a skill which deserves much attention every bit as much as other language skills are concerned, in both first and second languages since in EFL classrooms, teaching speaking plays a great role for the learner's good oral achievement ( Bygate, 1987, p01).He quoted that: *"Speaking is the vehicle par excellence of social solidarity, of social ranking, of professional advancement and of business .It is also the medium through which much language is learnt, and which for many is particularly conducive for learning. Perhaps, then, the teaching of speaking merits more thought"*

### 3. Teaching English at Primary Schools

Teaching English at primary schools is exceptional since it deals with children who have unique characteristics such as egocentrism, imagination, self-centered, learning by doing, getting board easily, and eagerness of learning new things (kahyati& Madya, 2019).

An efficient and effective learning of a language requires a supportive environment and a skillful teacher who knows how to deal with the different characteristics and learning profiles of his students. In addition to knowing how to exploit these characteristics and energy as well in learning for example providing them with activities like singing, playing game, telling stories will help them learn the target language easily since it is known that children are very active during their day, (kahyati and Madya, 2019).

### 3.1. The Types of Tasks and Activities in the Classroom

Learning and teaching activities differ from one method to another. According to the CBA, learning tasks are similar to those of communicative language teaching. As Richard and Rodgers (2001, p143) said “*that the competency-based language teaching shares some concepts of the communicative competence which considers the important elements to promote functional communicative skill of the learner*”. Indeed, the CBA has much in common with the previous approach of the communicative language teaching. In this respect, the CBA is eclectic in that it requires the use of different methods and techniques.

According to Biolobrzaska (2006, p96 ) the learning approach is a series of activities that learners are expected to do it in order to be competent in their life tasks. He said that “*the learning cycle is some new activities which learners should respond to it (discussion of issues raised in the activity) and should give the reflection that lead them to do another new activity and so on*”. The CBA contains a variety of learners’ tasks which all of them aim to develop their competence in real life situations. The following types of activities mentioned by Richards (2006):

- a- Information-gap activities:** these refer to that students in the classroom go beyond practice of language forms and they use their linguistic and communicative skills in order to obtain information.
- b- Task-completion activities:** they are also called warm-ups tasks. These kinds of activities motivate and push the learner to interact during a lecture such as games, puzzles, and songs.
- c- Information gathering activities:** the role of the students is to conduct surveys, interviews and search to collect information they needed.
- d- Information-transfer activities:** they focus on mental use of language. Learners are expected to transfer information from text to graphic or putting sentence elements in sequence.

In addition to the above-mentioned activities the CBA favors group work activities. According to Harmer (2001) group work encourages both the teacher and learners to do their tasks effectively, and promotes learners’ autonomy. Finally and most importantly, the project work is considered as an important activity of the CBA, since it was defined as a learner-oriented activity which can be carried out individually or in groups (Fried- Booth, 1986). It usually results in building learners’ confidence, improving their language skills and cognitive

abilities as well as providing a practicality rout towards autonomy which constitutes a major goal of nowadays education system (Thomas, 2000).

### **3.2. Lesson planning**

The following stages have been adapted from Madeline Hunter's (2006) eight steps lesson, design which comprises the following: anticipatory set, objective and purpose, input, modeling, checking for understanding, guided practice, independent practice and closure. These steps have been summarized into the four stages below to suit the CBA with entry through real life situations.

#### **3.2.1. Presentation of the problem-solving situation**

This is the discovery phase and it contains new notions to be discovered by learners. The teacher presents the problem and gives instructions to learners to gather and analyze data then develop and give a plan. While he/she monitors the effectiveness of their research. The learners would define the problem as they understand it.

#### **3.2.2. Systematization**

After examining and bringing out the relationship between previously learned elements and elements found in the new problem-solving situation, learners come out with rules (hypothetical). This is done with the help of the teacher.

#### **3.2.3. Application**

Here, the teacher gives tasks where learners apply the new knowledge. He/she assists (scaffolds) the learners accomplish the new task, supports them till they acquire the new skills and strategies.

#### **3.2.4. Partial Integration activities**

The teacher presents a new complex situation that will necessitate the exercise of the skill to solve a problem which is similar to the competence/skill the learners used at the beginning of the lesson. It should be noted also that partial integration activities are not done systematically at the end of every lesson. Also, they have to be concrete real-life situations.

### **3.3. The use of Materials in the Classroom**

#### **3.3.1. Textbooks as a Teaching Material**

Materials are resources for whatever procedures are used in specific classrooms, and one of the most important instructional materials as well as the most useful in the classroom is the textbook. The course book has become an almost universal element of ELT, playing as it does

a vital and positive part in the everyday job of teaching and learning of English (Hutchinson and Torres, as cited in Tomlinson, p.37).

The textbook is a book used as a standard source of information for formal study of a subject and an instrument for teaching and learning (Graves, 2000). It is regarded as one of the many sources that teachers can draw upon in creating an effective lesson and offer a framework of guidance and orientation as well. The textbook provides confidence and security, especially for those inexperienced teachers. The textbook plays a remarkable role in the teaching and learning process by which it represents a useful resource for both the teacher as a course designer and the learner who is acquiring the English language. In other words, it is not only the teacher who has a significant impact on the use of textbook, but also the learners' reaction to it is taken into consideration; the textbook is considered as one of the most important sources of contact that they have with the language as it is also a framework or guide that helps them to organize their learning (Graves, 2000).

### 3.3.1.1. What is a Textbook?

A Textbook (or a course book) is a teaching tool that is used in teaching English language in the classroom. It is produced according to the demands of educational institutions. Moreover, it is a useful source for the teacher to control the presented language and provide the learning process with suitable exercises and materials. As a pedagogical concept, many definitions were given by researchers to textbook.

“Textbooks visibly reflect pedagogic considerations. That is, a textbook is not just a book used in schools. Rather, it is a book that has been consciously designed and organized to serve the ends of schooling. To this extent, then, textbooks are organically linked to the changing circumstances of schooling. Indeed, it should be possible to „read off“ forms of schooling from the textbooks that accompany them.”(Hamilton, 1990).

Textbook is defined by the Oxford Dictionary (2008, p.459) as a “Book that teaches a particular subject, used in schools”.

Byram (2000,p. 626) states that:

“Textbooks are one particular resource amongst an increasingly wide and diverse range of teaching materials. They are bound collections of textual and visual material, designed for teaching and learning a particular subject and following particular methodological and didactical principles.”

Hutchinson and Torres (1994, p 135) define textbook with a particular reference to English language teaching. Here is what they say about it:

“The textbook is an almost universal element of [English language] teaching. Millions of copies are sold every year, and numerous aid projects have been set up to produce them in various countries...”.

What all the above-mentioned definition stress is the fact that textbooks are tools that used in teaching. They are designed depending on some features, such as the inclusion of texts and images. Besides, they are based on particular methods and instructions in order to facilitate language teaching and learning.

### 3.3.2. Textbook of 3rd Year Primary School

CNP (2022) This book is the first in the English language for pupils who are about to learn this language for the first time in school. Through it, this book will enable them to learn the English language through the practice of activities that give the pupil the opportunity to communicate orally with his colleagues and teachers, according to what was stated in the introduction to this book.

The English language book provides valuable information that helps the pupil to speak in English and to write it easily, and enables him to open up to the outside world and reach modern information through the English language.

The English language book for the third year of primary school bears the title My Book of the English Language. This book, approved by the Ministry of Education and National Education, consists of 64 pages and a size of 20 cm / 28 cm. Its price is 180 DZD.

- Regarding the contents of the book, it is varied and includes a rich program in it: the learner's family, his school, his environment, his game, and the pets he loves, to enable the student to communicate with his friends inside and outside the country on holidays and occasions.
- This book will also help the learner to “speak and write in English easily, and enable him to open up to the world and enhance his love for his country.”
- This book also includes various activities that allow the learner to get acquainted with this language and allow him to communicate with others in a sound and easy language and to write the English language correctly and easily.
- The English language book reinforces the national values of the student. Through the cover, national colors were chosen that radiate the element of suspense and patriotism through the use of national colors. The cover of the book bears two pictures of the students "Yassin" and "Maryam", who are considered the main characters in the content of the book.

This book was written and prepared according to the curricula of the Ministry of National Education related to the primary education stage with regard to the English language and according to the pedagogical conditions book issued by the Accreditation Committee of the Technological Institute for Research in Education.

**3.3.2.1. Topics And Communicative Objectives**

TOPICS	COMMUNICATIVE OBJECTIVES
<i>ME, MY FAMILY AND MY FRIENDS</i>	<ul style="list-style-type: none"> <li>- Greeting people/Leave taking</li> <li>- Introducing oneself, family, friends</li> <li>- Saying numbers</li> <li>- Asking about age and place of residence</li> </ul>
<i>MY SCHOOL</i>	<ul style="list-style-type: none"> <li>- Naming school objects</li> <li>- Naming colours</li> <li>- Asking about and locating school objects</li> <li>- Naming days of the week</li> <li>- Asking about school timetable</li> </ul>
<i>MY HOME</i>	<ul style="list-style-type: none"> <li>- Naming rooms</li> <li>- Asking about their location</li> <li>- Locating people inside a house</li> <li>- Following instructions</li> </ul>
<i>MY PLAYTIME</i>	<ul style="list-style-type: none"> <li>- Naming and asking about favourite toys</li> <li>- Identifying toys</li> <li>- Asking about colours</li> </ul>
<i>MY PETS</i>	<ul style="list-style-type: none"> <li>- Naming pets</li> <li>- Describing pets: identifying their size and parts</li> <li>- Asking and giving information about pets</li> </ul>
<i>MY FANCY BIRTHDAY</i>	<ul style="list-style-type: none"> <li>- Naming objects and foods related to birthday celebration</li> <li>- Naming different face parts</li> <li>- Expressing offers and thanks</li> <li>- Responding to offers and thanks</li> <li>- Expressing wishes, feelings and emotions</li> <li>- Following instructions</li> </ul>

**Table 01: Topics and Communicative Objectives (CNP 2022.P8)**

**3.3.3. Role of the Textbook in the Classroom:**

Textbooks play a crucial role in the process of teaching and learning a language. However, besides their advantages, they also have disadvantages.

Cortazzi and Jin consider textbook as the key element in foreign language classroom. They argue that the textbook can function as a teacher, whereby, it gives students knowledge and instructions about foreign cultures. Besides, it can work as a trainer guiding inexperienced teachers in their teaching, hence its unparalleled usefulness as a material for teachers. Also, it

is a resource from which both students and teachers can easily select the appropriate items to be taught and learned. Moreover, the textbook can be a map. In other words, it gives an overview of an organized curriculum which consists of both linguistic and cultural aspects. It can also be seen as an authority in the sense that it is an authentic, valid, and reliable material. The textbook can be seen as an ideology in the sense that it can function as a social and cultural construction for both teachers and students (1999). Advocacy of course books has come from scholars who strongly believe that coursebooks should be seen as a means of re-skilling“ rather than „de-skilling“ teachers (O’Neil, 1982; Hutchinson and Torres, 1994; Edge and Wharton, 1998) and that, provided they are used flexibly, they can be adapted and supplemented to meet the needs of specific classes (Bell and Gower, 1998:117) (as cited in Brian 2014, p. 39). They state the following advantages for the use of course books:

1. Coursebooks meet a wide range of practical needs, particularly in contexts where English is being taught in a non-English-speaking environment and where teachers either lack training or sufficient time to analyze each group’s needs.
2. Coursebooks help provide a route map for both teachers and learners, making it possible for them to look ahead to what will be done in a lesson as well as to look back on what has been done.
3. Coursebooks provide structure and predictability, which help give the participants in social interactions, like lessons, a safe base, a platform for negotiation and exploration.
4. By dealing with a certain amount of routine work for teachers, course books free them to attend to more important aspects of lesson planning (including materials adaptation and supplementation), and to concentrate on using their creative skills.
5. Coursebooks provide teachers, particularly those lacking in training and experience, with a sense of self-confidence and security.
6. Most coursebooks are designed and developed by experts in the field, conversant with current theoretical approaches and methodological practices. The quality of sophistication in their design, content and organization would be difficult to match with home-grown materials.
7. Coursebooks can act as agents of change, allowing innovative ideas to be introduced within their structured framework in a way that enables teachers and learners to develop in harmony with these new ideas. Indeed, Edge and Wharton (1998) see the ELT course book functioning as a genre of mass communication, where its authors can enter into positive dialogue with teachers and students on a number of issues of current significance to ELT professionals (Brian, 2014, p. 39).

Although textbooks have advantages, they also have disadvantages. According to Gimeno (1988), textbooks cannot deal with all aspects such as dealing with all learning styles, and every category of learning strategies. Also, it cannot reach all students' needs. Moreover, the content of textbook may be irrelevant and not interesting to both teachers and students. Ur (1996, pp. 183-195) adds that textbooks may restrict the teachers' creativity and kills their freedom as well as preventing them to give negative judgments about the content. Harmer (1991, p. 257) states that when teachers overuse the textbook in teaching, learners will "find the study of English becoming routine and thus less and less motivating".

### **3.4. The Evaluation under the CBA**

Evaluation under the CBA needs to be performance-based. It is of two types, formative or summative. The formative is ongoing and continuously used all along the route toward the prescribed competency. Summative assessment, on the other hand, determines competency mastery; it is administered as a final test. Failure in summative tests equals retaking the same module and not moving on to the next competency. The summative assessment, as stated by Griffith and Lim (2014), needs to involve performance-based tests not fill –in- the-blank, and multiple-choice tests. Docking (1994) shares the same stand when he says that "instead of norm-referencing assessment, criterion-based assessment procedures are used in which learners are assessed according to how well they can perform on specific tasks." Assessment under the CBA needs to consider not what they know, but how far they can meet the standards of the specific tasks. Assessment under the CBA is criterion-referenced instead of norm-referenced.

### **Conclusion**

This second chapter has provided a general overview of English comprehension abilities. After giving a general overview about comprehension abilities, it moved to speak about The Types of Tasks and Activities in The Classroom, The use of materials in the classroom, Lesson planning, Textbook of 3rd year primary school, Topics And Communicative Objectives, Role of the Textbook in the Classroom and The evaluation under the CBA. This chapter discussed comprehension abilities and a short description of 3<sup>rd</sup> year textbook of English in primary schools. The comprehension ability is fundamental in learning a new language. For this purpose, the next chapter will present a case study, which will deal with the comprehension abilities of the 3rd year primary school learners and the implementation of CBA.



## **Introduction**

Teaching English at primary school in Algeria has become a challenging topic for both teachers and learners. Accordingly this research is conducted to collect data about primary schools teachers of English and learners.

This chapter presents the practical part, it included the research methodology, the sample selected and explains the steps conducted in order to collect data, analyze the data, the discussion of the findings to answer the research questions and to confirm the hypotheses or deny them.

### **1. The Sample**

The sample of the study consists of primary teachers of English in the academic year 2022-2023 in the city of Metlili (7 teachers from all primary school of Metlili.(32 primary schools) each one of them teach in four or five schools) and 3<sup>rd</sup> year pupils at Ibn Badiss primary school of Metlili (57 pupils). We have chosen the primary teachers of English to be used in our study because these teachers have a great relation with the subject, as they can recognize the problems that face them in the use of the competency-based approach in teaching English in primary school and the pupils of 3<sup>rd</sup> year to measure the development of comprehension ability. This could provide teachers and pupils with better insight about the main problems that hinder the EFL teachers in teaching English in primary school under the competency-based approach.

### **2. Data Collection**

#### **2.1 The Questionnaire**

The aim of this questionnaire is to investigate the effectiveness of using CBA in teaching English in primary. It also aims to know how to implement this approach in order to enhance pupils' comprehension abilities and to use them in real life. This questionnaire; therefore, helps the teacher to find out whether teaching English under the CBA is really used in achieving learners' progress in learning English as a second foreign language.

##### **2.1.1 Description of the Questionnaire**

"The questionnaire is a widely used and useful instrument for collecting survey information, providing structured, often numerical data, being able to be administered without the presence of the researcher, and often being comparatively straight-forward to analyze"(Wilson& McLean, 1994, cited in Cohen, Manion & Morrison, 2005, p.245). The questionnaire was distributed to seven (07) teachers at primary schools at Metlili (from all the

primary schools of Metlili (32 primary schools) each one of them teach in four or five schools). It consists of two main sections.

**Section one:** it contains questions from 01 to 12. This section is about teaching English under the Competency-Based Approach. Those items seek for the use of helping materials, the use of textbook, the use of mother tongue in classroom, the use of CBA and the role of teacher under CBA.

**Section two:** this section is about teachers' problems and difficulties in teaching English in primary school under CBA. It contains questions from 01 to 09 that examine the time taken in teaching, teaching in large classes, the needed materials, instruction and guidance needed in teaching process learners' interaction, difficulties in teaching at different schools and causes behind the teacher classroom's problems. It investigates the main problems in teaching English under the CBA in primary school classes.

## **2.2. The Test**

The aim of this test is to measure the comprehension ability of pupils under the use of CBA in teaching English in primary. It also aims to know what skill pupils prefer. This test therefore, helps to find out the points of Strength and weakness of pupils and their needs. It is really helpful in learning English as a second foreign language.

### **2.2.1. Description of the Test**

This test is used in order to verify, measure and evaluate the pupil's level of comprehension of activities, as well as to see if he uses all of the four skills, which is the aim of this research. The best way to know the level of the student is the test, whether it is in written or oral form, all of them are considered as a gateway in order to enter the pupil's mind and understand his intellectual level in order to find solutions to any problem and complement the deficiencies according to his needs. All this we can only know through testing Fifty Seven (57) pupils from Ibn Badiss primary schools at Metlili answered the test. It consists of four (04) activities each one related to a different skill.

- **Activity One:** this activity contains one question about listening comprehension.
- **Activity Two:** contains questions about written comprehension.
- **Activity three:** this activity contains phrases to read.(Reading comprehension).
- **Activity four:** this activity contains questions about Greeting, school things, house rooms, toys and pets about speaking comprehension.

### 2.3 The Interview

The interview is the second supportive instrument used in this study to collect qualitative data. It is simply defined by Gillham (2000. P1) as “*a conversation where one person –the interviewer –is seeking the response for a particular purpose from the other person –the interviewee*”. Our present interview took place during the academic year 2022/2023 on May,07 in Ibn Badiss primary schools at Metlili. Its purpose was to investigate the main competences that the teacher should focus on, the use of techniques and the training of teachers. This interview contains ten (10) questions conducted precisely with the teacher of English in Ibn Badiss primary schools at Metlili. It was face to face questions after getting the permission from administration.

#### 2.3.1 Description of the Interview

This interview is used as a supporting material to collect data from the teacher of English in the primary school of Ibn Badis at Metlili. The interview combines ten questions designed in order to know main competences -the primary school-that the teacher should focus on and if the competency-based approach helps increase pupils’ comprehension.

### 3. Data Analysis

Data analysis refers to the process of bringing order, structure and meaning to the mass of the collected data. (DeVos, Strydom, Fouché, & Delpport, 2002).

#### 3.1 Analysis of the Questionnaire

##### Section one: Teaching Methodology

**Q1: To which extent do you rely on the textbook provided by the ministry of education?**

**Always -Usually - Rarely - Never**

	<b>Option</b>	<b>Number of Teachers</b>	<b>Percentage %</b>
<b>1</b>	<b>Always</b>	<b>2</b>	<b>29%</b>
<b>2</b>	<b>Usually</b>	<b>4</b>	<b>57%</b>
<b>3</b>	<b>Rarely</b>	<b>1</b>	<b>14%</b>
<b>4</b>	<b>Never</b>	<b>0</b>	<b>00%</b>

**Table 02: Relying on textbook**

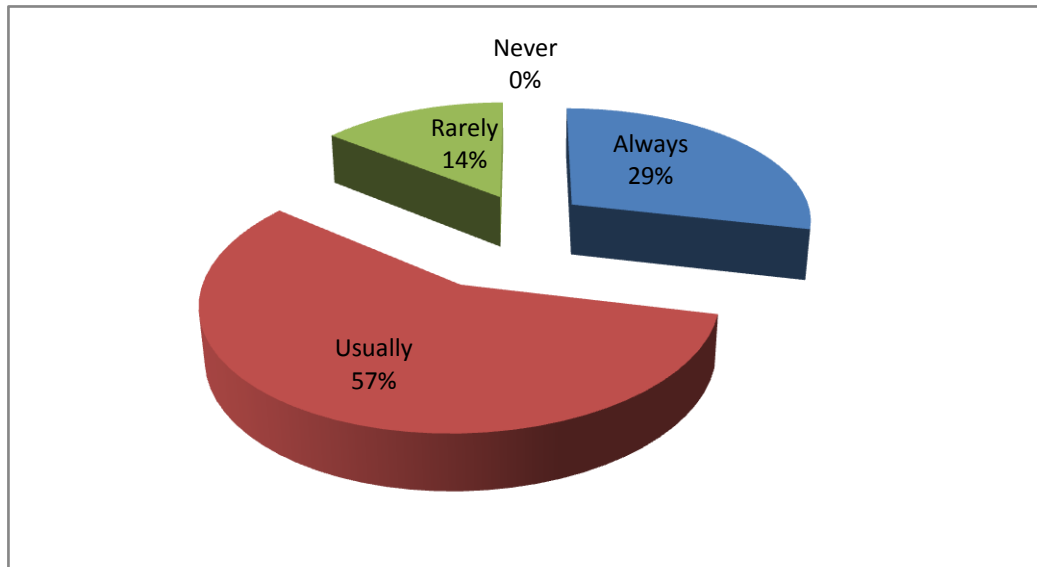

**Figure 02: Relying on textbook**

The results in table 02 Show that 57% from the teachers usually rely on the textbook provided by the ministry of education, 29% from teachers always rely on the textbook, 14% rarely rely on the textbook and 0% never relies on textbook.

**Q 2: How often do you use the mother tongue in classroom explanation?**

Always - Usually - Sometimes - Never

	Option	Number of Teachers	Percentage %
1	Always	0	00%
2	Usually	2	29%
3	Sometimes	4	57%
4	Never	1	14%

**Table 03: The use of mother tongue in classroom explanation**

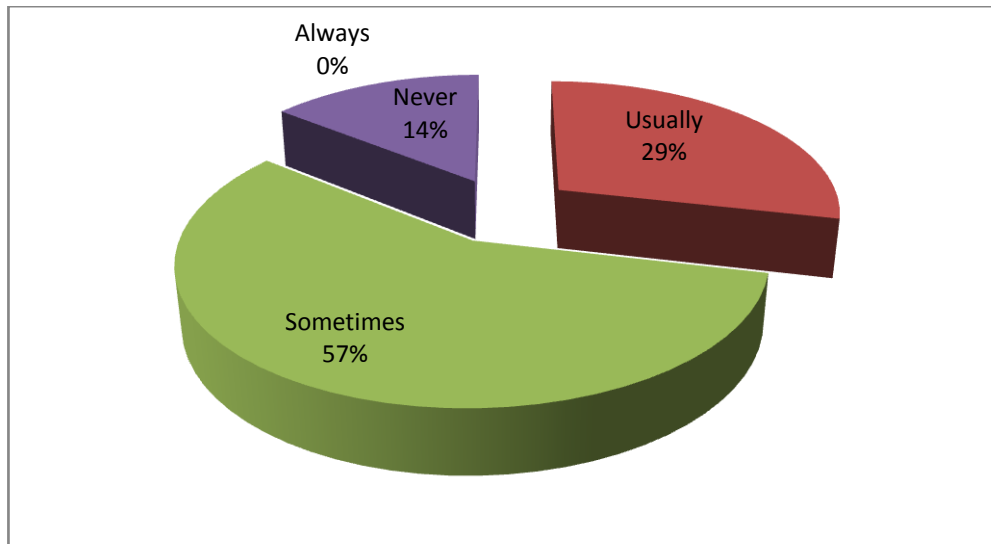

**Figure 03: The use of mother tongue in classroom explanation**

The results in table 03 show that 57% from teachers sometimes use the mother tongue in classroom explanation which represent the highest percentage, 29% usually use it, 14 % never use it and 0% from them always use it .

**Q3: How often do you use CBA?**

Always - Usually - Sometimes - Never

	Option	Number of Teachers	Percentage %
1	Always	4	00%
2	Usually	1	29%
3	Sometimes	2	57%
4	Never	0	14%

**Table 04: The use of CBA**

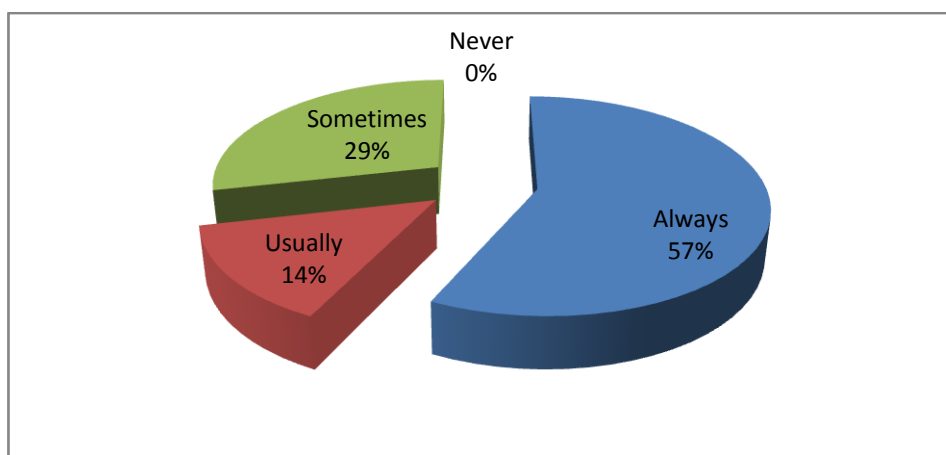

**Figure 04: The use of CBA**

The results in table 08 Show that 57% from teachers always use the CBA which represent the highest percentage ,29% sometimes use it,14 % usually use it and 0% from them never use it. So here the most of teachers use the CBA in teaching English.

**Q 4: The teacher's role in the CBA should be:**

**A facilitator - A conventional information-provide - A Guider**

	Option	Number of Teachers	Percentage %
1	A facilitator	2	29%
2	A conventional information-provide	0	00%
3	A Guider	5	71%

**Table 05: The teacher's role in the CBA**

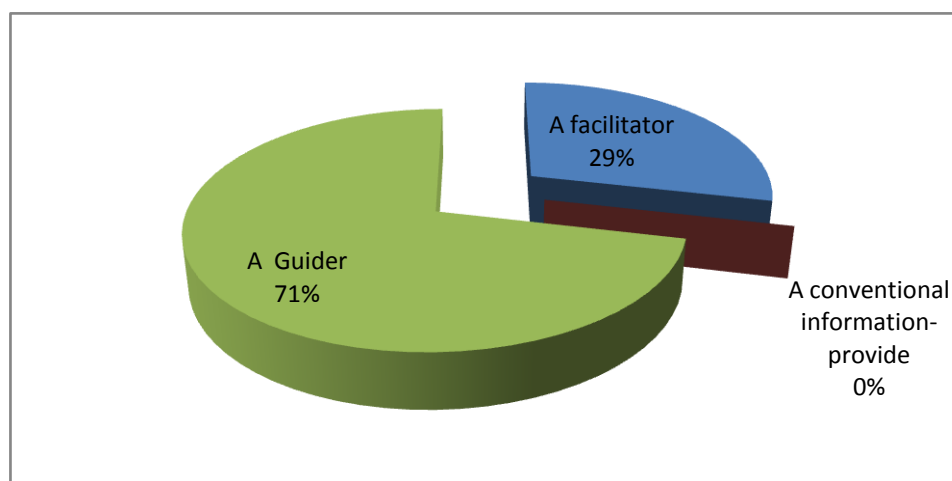

**Figure 05: The teacher's role in the CBA**

The results in table 05 Show that 71% from teachers are guiders, 29% as a facilitators and 0% from them are a conventional information-providers. So here the most of teachers are guiders for pupils.

**Some explanations for the choice of answer:**

- The centered learner method the teacher is a guider
- Teachers play a critical role in the success of CBA by providing effective and meaningful feedback to students, identifying areas that require improvement, and utilizing assessments to continuously improve the teaching and learning process.
- Teacher guides learners when he uses CBA.
- Try to be as inductive as possible; the last resort for me is providing information.

**Q 5: Do learners interact with each other?**

**Always - Usually - Sometimes - Never**

	<b>Option</b>	<b>Number of Teachers</b>	<b>Percentage %</b>
<b>1</b>	<b>Always</b>	<b>0</b>	<b>00%</b>
<b>2</b>	<b>Usually</b>	<b>2</b>	<b>29%</b>
<b>3</b>	<b>Sometimes</b>	<b>5</b>	<b>71%</b>
<b>4</b>	<b>Never</b>	<b>0</b>	<b>00%</b>

**Table 06: Learner’s interaction**

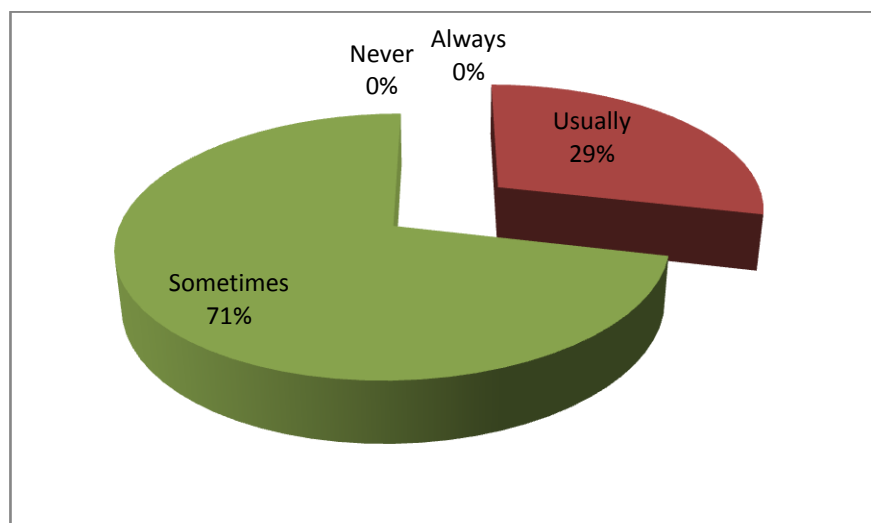

**Figure 06: Learner’s interaction**

The results in table 06 Show that 71% from learners sometimes interact with each other, 29% usually interact with each other, 0 % always interact with each other and 0% from them never interact with each other. So here the most learners sometimes interact with each other.

**Q6: Which of the following skills your pupil’s best preferred?**

**Listening - Speaking - Reading - Writing**

	<b>Option</b>	<b>Number of Teachers</b>	<b>Percentage %</b>
<b>1</b>	<b>Listening</b>	<b>3</b>	<b>33%</b>
<b>2</b>	<b>Speaking</b>	<b>4</b>	<b>45%</b>
<b>3</b>	<b>Reading</b>	<b>1</b>	<b>11%</b>
<b>4</b>	<b>Writing</b>	<b>1</b>	<b>11%</b>

**Table 07: Skills that pupil prefer**

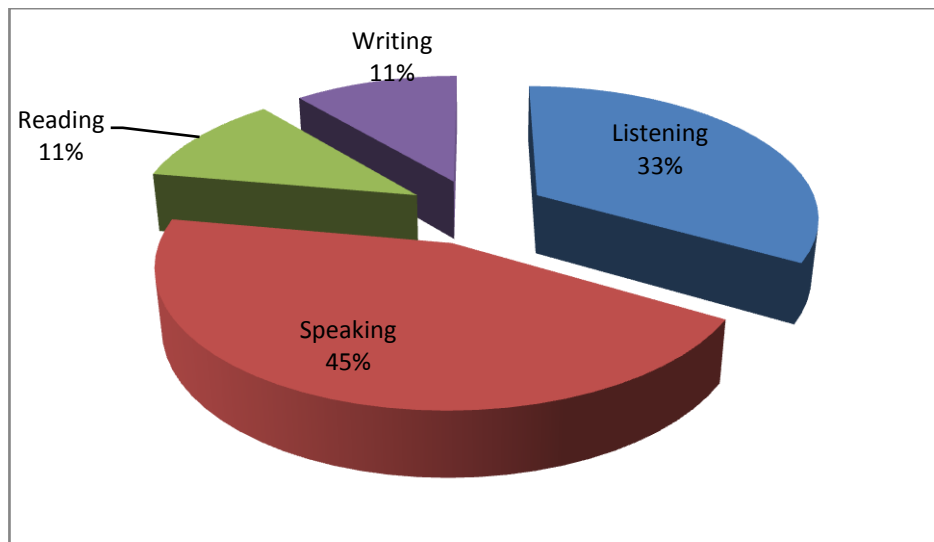

**Figure 07: Skills that pupil prefer**

The results in table 07 Show that 45% from pupils prefer speaking skill, 33% from them prefer listening skill, 11 % from them prefer reading and 11 % from them prefer writing skills. So the majority of pupils prefers speaking and listening skills and pay less attention to the reading and writing skills.

**Q 7: Do you praise your learners?**

**Always - Usually - Sometimes - Never**

	<b>Option</b>	<b>Number of Teachers</b>	<b>Percentage %</b>
<b>1</b>	<b>Always</b>	<b>5</b>	<b>71%</b>
<b>2</b>	<b>Usually</b>	<b>2</b>	<b>29%</b>
<b>3</b>	<b>Sometimes</b>	<b>0</b>	<b>00%</b>
<b>4</b>	<b>Never</b>	<b>0</b>	<b>00%</b>

**Table 08: Learner's praising**



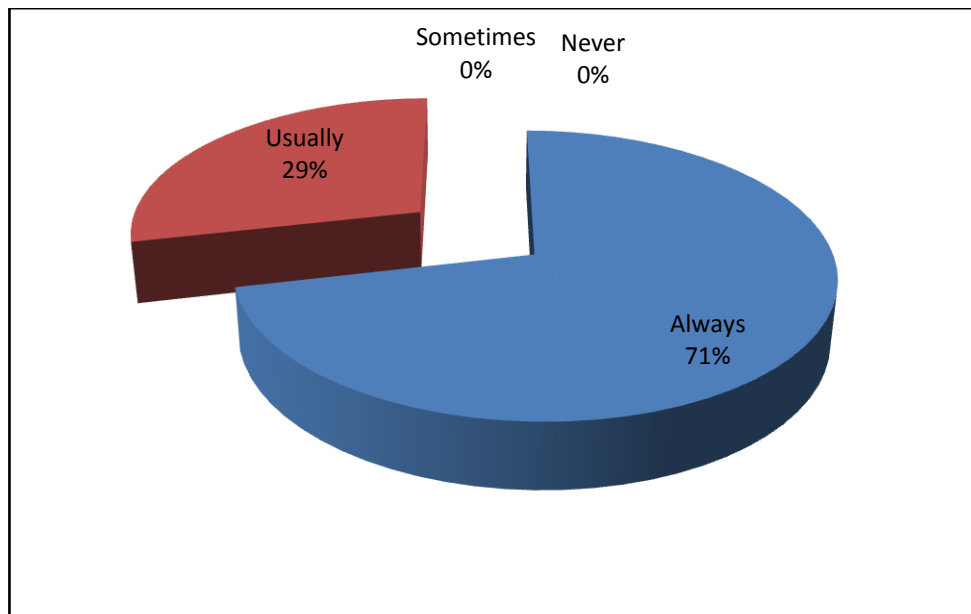

**Figure 08: Learner's praising**

The results in table 08 Show that 71% from teachers always praise learners, 29% from them usually praise learners, and 0% from them sometimes praises learners and 0% from them never praises learners. So here the most of teachers always praise learners and that will make the learners more motivated.

**Q 08: Which ones of the following materials do you use in the classroom?**

**Role play-Flash aids-Games-Songs-Images-Teachers' gestures -computer-Datashow – others**

	Option	Number of Teachers	Percentage %
1	Role play	5	16%
2	Flash aids	4	13%
3	Games	1	3%%
4	Songs	5	16%
5	Images	7	23%
6	Teachers' gestures	6	20%
7	Computer	1	3%
8	Data show	1	3%
9	Others	1	3%

**Table 09: Materials used in the classroom**

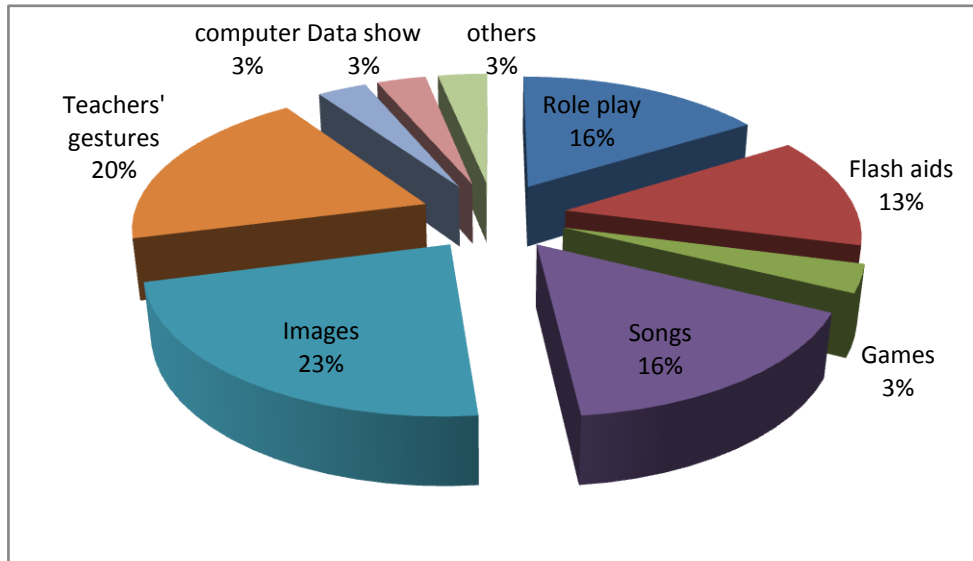

**Figure 09: Materials used in the classroom**

The results in table 09 Show that 23% from teachers use images as a teaching materials ,20% from them usually use teachers’ gestures,16% from them use songs, the same percentage for role play,13% flash aids, 3% data show the same percentage for games, also 3% others materials and also 3% from computer . So here the most of teachers use images as a very important material in teaching English in primary school.

**Q 9: Does the textbook help the learners to work in pairs or groups?**

Yes - No

	Option	Number of Teachers	Percentage %
1	Yes	6	86%
2	No	1	14%

**Table 10: Textbook help learners to work in pairs or groups**

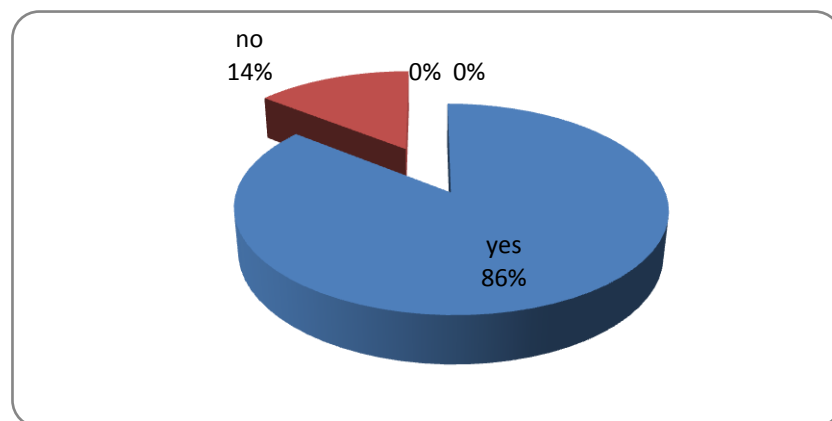

**Figure 10: Textbook help learners to work in pairs or groups**

The results in table 10 Show that 86%from teachers said yes and confirm that Textbook help learners to work in pairs or groups and 14% from them said no textbook do not help learners to work in pairs or groups.

One of the teachers who said that textbook help learners to work in pairs or groups explained his/her opinion with this sentence:

- Textbook might include group discussion questions, group projects or assignments, or activities that require peer feedback and collaboration. In addition, sometimes textbook include activities that require students to work in pairs or small groups to solve problems or complete a task.

The teacher who said no explained his/her opinion with the following:

- Textbook for individual work but the sheets for group work.
- The type of tasks doesn't help the learners to work in pairs or groups.
- Is does not promote pair or team work but many activities could be done that way, the teacher is guided to devise the activities depending on what he sees right.

**Q 10:Do you feel that the textbook is appropriate for the pupil's level?**

	<b>Option</b>	<b>Number of Teachers</b>	<b>Percentage %</b>
<b>1</b>	<b>Yes</b>	<b>6</b>	<b>86%</b>
<b>2</b>	<b>No</b>	<b>1</b>	<b>14%</b>

**Table 11: Textbook and pupil’s level**

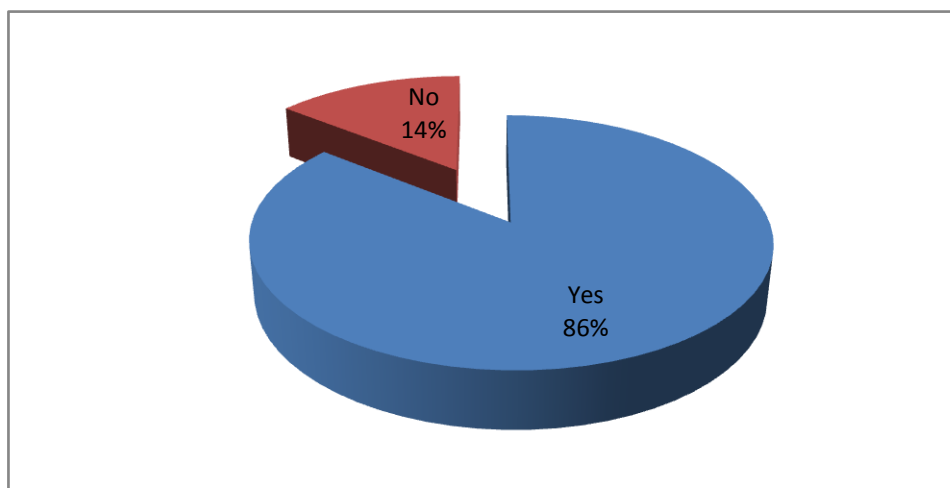

**Figure 11: Textbook and pupil’s level**

The results in table 11 Show that 86%from teachers said yes and confirm that Textbook is appropriate for the pupil's level and 14% from them said No textbook is not appropriate for

the pupil's level. So here we can say that the designer of this textbook take into account the level of the pupils.

**Q 11: Do you have tests to evaluate pupils' level, if yes how?**

	Option	Number of Teachers	Percentage %
1	Yes	7	100%
2	No	0	00%

**Table 12: pupils' evaluation**

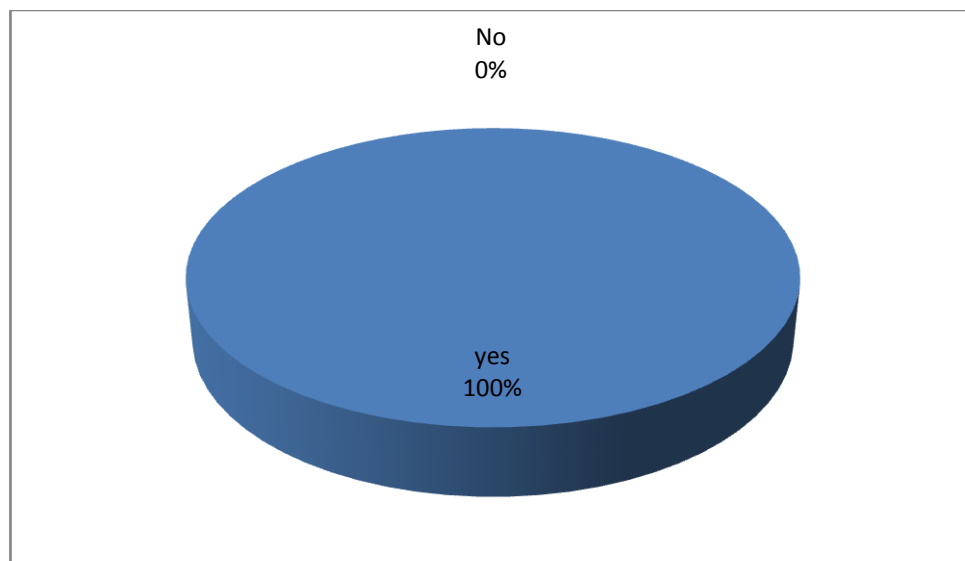

**Figure 12: pupils' evaluation**

The results in table 12 Show that 100% from teachers said yes and confirm the use of tests to evaluate pupils' level they mentioned the following:

- We have four rubrics: oral comprehension, written comprehension, oral production, written production (writing correct letters).
- The best way to evaluate pupils' level is using CCQs (concept checking questions)

By using various types of assessments, teachers can comprehensive understanding of pupils' levels of knowledge and understanding.

- Evaluation via tests oral checks.
- Giving them tests that contain the ideas of the lesson.

**Q 12: Do you encourage classroom interaction, If yes how?**

	Option	Number of Teachers	Percentage %
1	Yes	7	100%
2	No	0	00%

**Table 13: Classroom interaction**

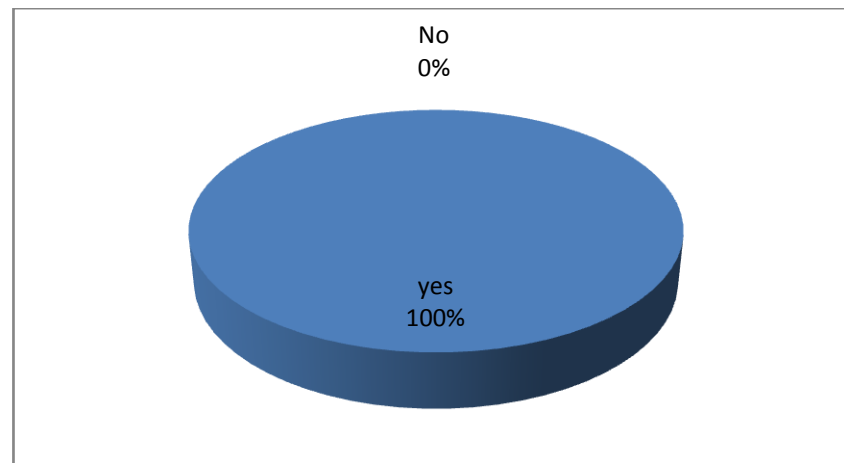

**Figure 13: Classroom interaction**

The results in table 13 Show that 100%from teachers answered positively and encourage classroom interaction in order the make the pupil feel comfortable and one of them said that:

- by creating a classroom environment where students feel comfortable to participate in classroom interaction, using technology facilitate classroom interaction, encouraging pupils to work in small groups, encouraging discussion, learners participate in role-playing, provide constructive feedback.

### **Section three: difficulties faced in teaching English**

#### **Q 1: Is time sufficient for teaching English?**

Yes – No

	<b>Option</b>	<b>Number of Teachers</b>	<b>Percentage %</b>
<b>1</b>	<b>Yes</b>	<b>2</b>	<b>29%</b>
<b>2</b>	<b>No</b>	<b>5</b>	<b>71%</b>

**Table 14: The time for teaching English**

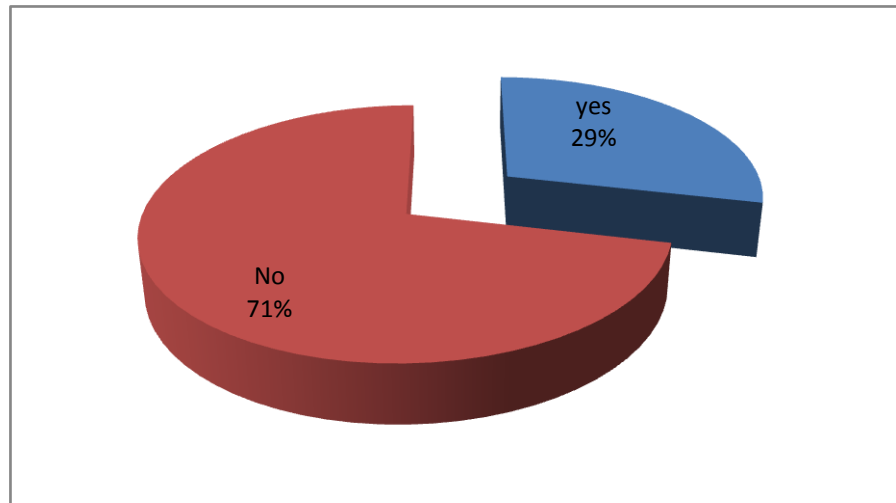

**Figure 14: The time for teaching English**

The results in table 14 Show that 29% from teachers said yes and confirm that the time is sufficient for teaching English and 71% from them said no the time is not sufficient for teaching English in primary schools. They have only 45 minutes each session and 90 minutes each week.

**Q 2: Do you have difficulties of teaching large classes?**

Yes – No - To some extent

	Option	Number of Teachers	Percentage %
1	Yes	6	86%
2	No	1	14%
3	To some extent	0	00%

**Table 15: Teaching large classes**

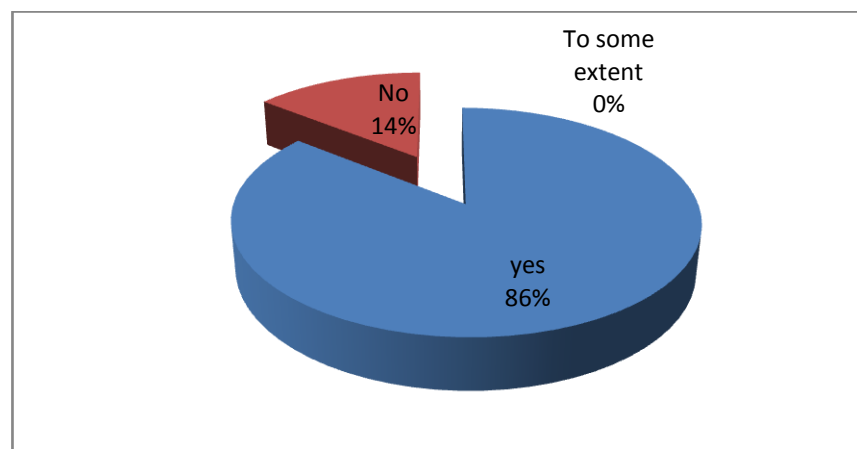

**Figure 15: Teaching large classes**

The results in table 15 Show that 86 %from teachers said yes and confirm that they have difficulties of teaching large classes and 14% from them said no they don't have difficulties of teaching large classes from here we can say that teaching large classes is very difficult for teachers.

**Q 3: The number of pupils in each class is:**

**Less than 25 students - Between 30 and 40 students - More than 40 students**

	<b>Option</b>	<b>Number of Teachers</b>	<b>Percentage %</b>
<b>1</b>	<b>Less than 25 students</b>	<b>1</b>	<b>14%</b>
<b>2</b>	<b>Between 30 and 40 students</b>	<b>5</b>	<b>72%</b>
<b>3</b>	<b>More than 40 students</b>	<b>1</b>	<b>14%</b>

**Table 16: The number of pupils in each class**

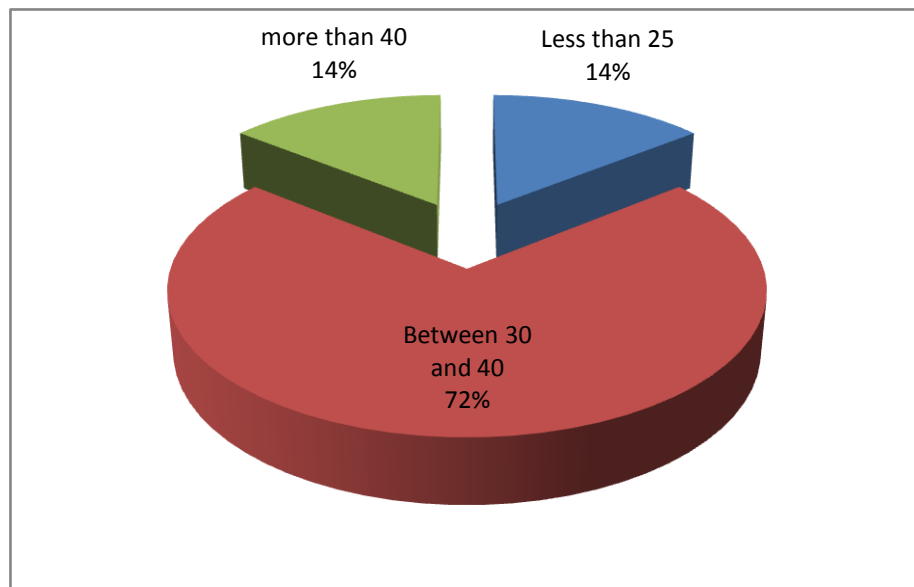

**Figure 16: The number of pupils in each class**

The results in table 16 Show that 72 %from teachers said that the number of pupils in each class is between 30 to 40 pupils, 14% said that the number of pupils in each class is more than 40 and 14% said that the number of pupils in each class is less than 25, so here we can say that the majority of teachers teaching more than 30 pupils in classes and it is not helpful at all to teach under CBA.

**Q 4: Do you have the needed materials to teach English in primary school**

Yes - No

	Option	Number of Teachers	Percentage %
1	Yes	2	29%
2	No	5	71%

**Table 17: The needed materials**

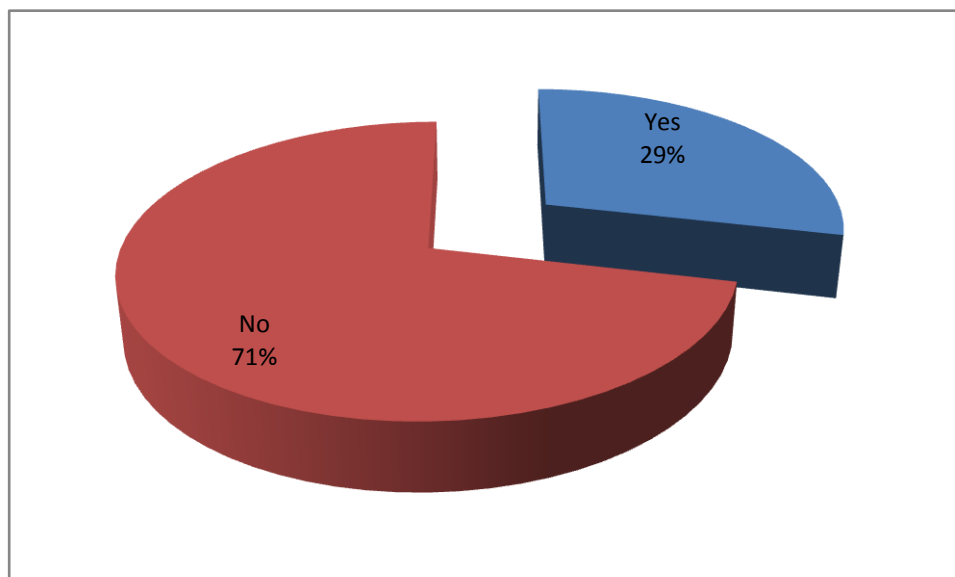

**Figure 17: The needed materials**

The results in table 17 Show that 29 %from teachers said yes and confirm that they have the needed materials and 71% from them said no they don't have the needed materials to teach English in primary school. Here the majority confirm that they don't have the needed materials and materials represent a very important element in the teaching and learning process.

**Q5: Do you have enough instruction and guidance needed in teaching process?**

Yes – No

	Option	Number of Teachers	Percentage %
1	Yes	4	57%
2	No	3	43%

**Table 18: Instruction and guidance**



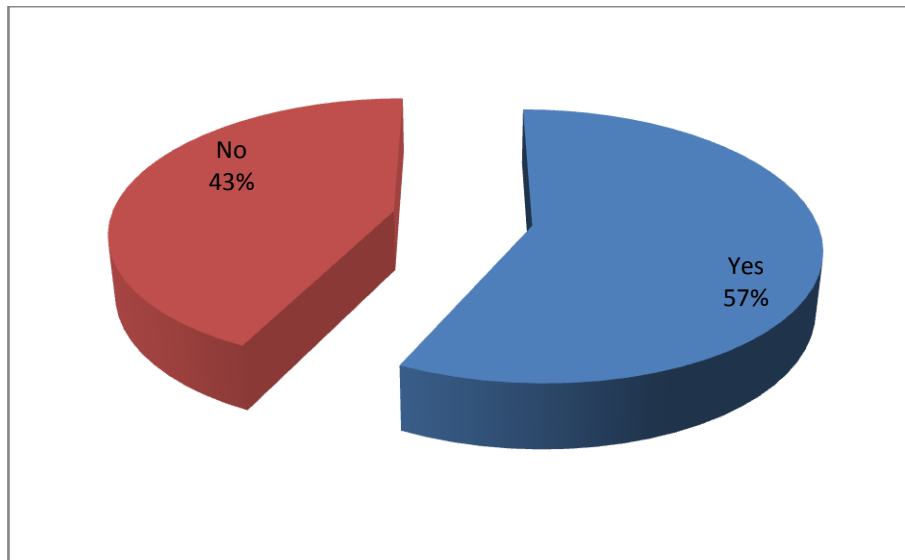

**Figure 18: Instruction and guidance**

The results in table 18 Show that 57 % from teachers said yes and confirm that they have enough instruction and guidance needed in teaching process and 43% from them said no they don't have enough instruction and guidance needed in teaching process. So here we can say that the most of them have enough instruction and guidance and it is positive thing in the teaching and learning process.

**Q 6: Do the learners engage and interact with the learning process?**

Yes – No

	Option	Number of Teachers	Percentage %
1	Yes	7	100%
2	No	0	00%

**Table 19: Engaging and interaction of learners with the learning process**

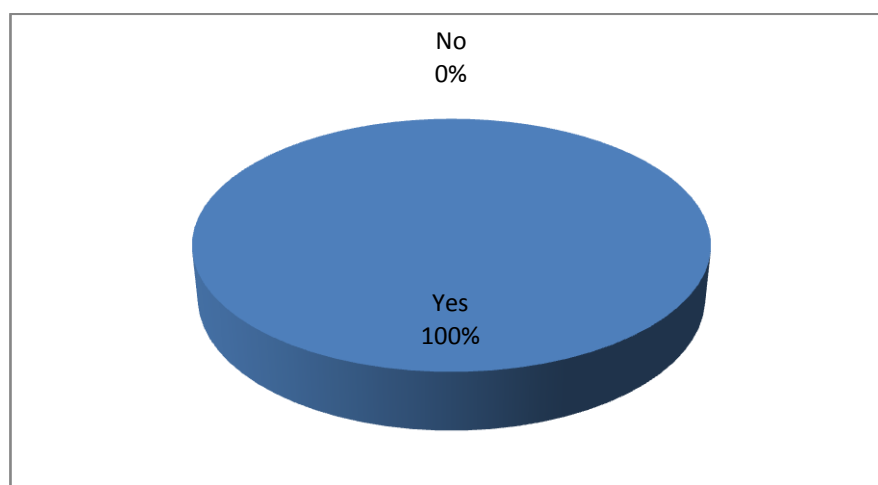

**Figure 19: Engaging and Interaction of learners with the learning process**

The results in table 19 Show that 100 %from teachers said yes and confirm that learners engage and interact with the learning process so here we can say that all the learners engage and interact with the learning process it is helpful for both teachers and learners.

**Q 7: Do you have difficulties in teaching at different schools**

Yes – No

	Option	Number of Teachers	Percentage %
1	Yes	6	86%
2	No	1	14%

**Table 20: Difficulties in teaching at different schools**

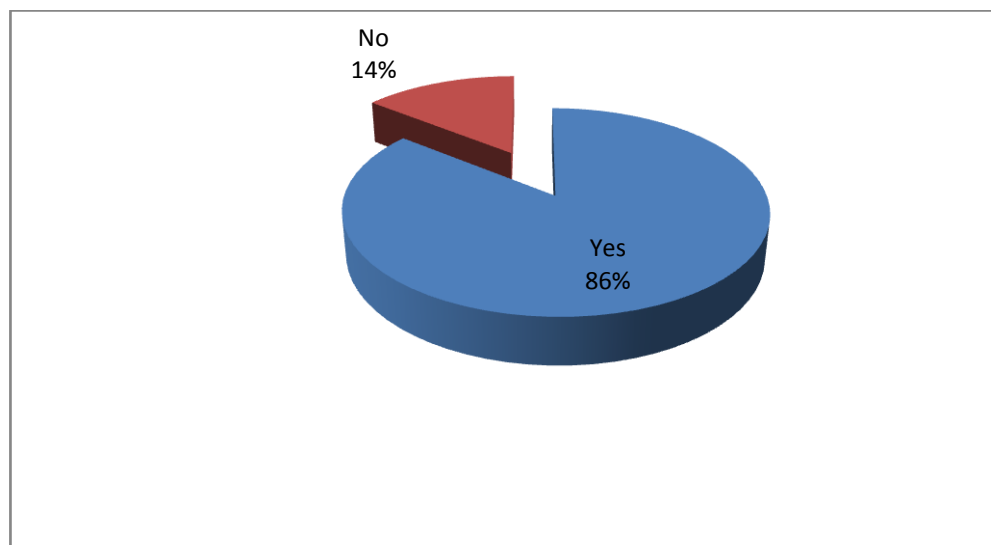

**Figure 20: Difficulties in teaching at different schools**

The results in table 20 Show that 86 %from teachers said yes and confirm that they have difficulties in teaching at different schools and 14% from them said no they don't have difficulties in teaching at different schools. From here we can say that teaching at different schools is not positive thing and it is not helpful for teachers.

**Q 8: How can you help your pupils who do not understand the task?**

**The answers of teachers :**

- Either explain in simpler words or apply scaffolding by peers: ask another pupil to help them, they do it better sometimes.
- By repeating the statements in other ways
- To use more facilitators.
- I can answer any questions they may have about the task and provide guidance on how to approach it.

- Explaining
- By giving them simple examples
- Using gestures to clarify

From the answers of teachers we can notice that each one of them has his own way to explain and to clarify

**Q 9: according to you as a teacher what are the causes behind your classroom's problems?**

**Lack of time - Lack of information -The huge number of pupils –Others**

	Option	Number of Teachers	Percentage %
1	Lack of time	4	28%
2	Lack of information	1	07%
3	The huge number of pupils	5	36%
4	Others	4	29%

**Table 21: The causes behind classroom's problems**

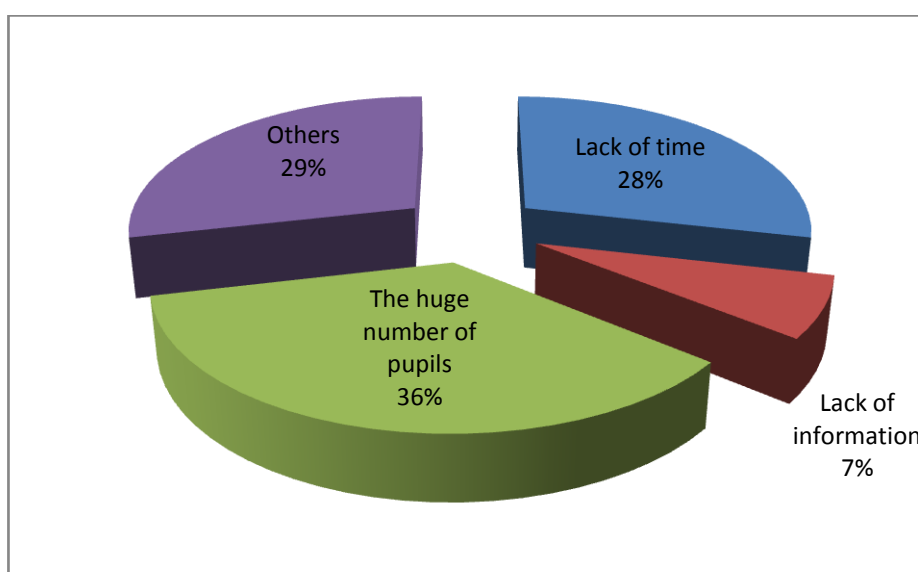

**Figure 21: The causes behind classroom's problems**

The results in table 21 Show that 36 %from teachers said that the causes behind classroom's problems is the huge number of pupils, 29% from them said that there are others causes behind classroom's problems, 28% from them said that the causes behind classroom's problems is lack of time and 7% from them said that lack of information is the cause behind classroom's problems.

Teachers who said others causes explain their choice as follow:

- Lack of practical training on classroom management.
- Lack of materials and working in 4 schools
- We need more materials
- Lack of materials
- To practice CBA in the perfect way we need to avoid teaching at large classes.

**3.2 Analysis of the test**

**Activity 01:**This activity contains one question about listening comprehension

**Listen then match the word with the sound /D/**

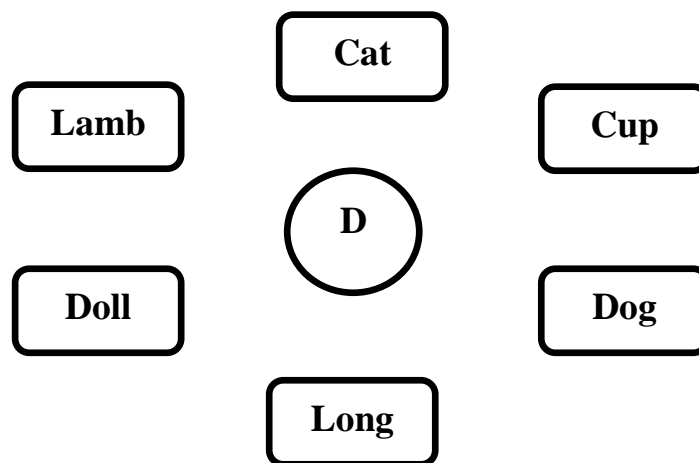

**Figure 22: Activity 01 Listen then match**

	Level	Number of pupils	Percentage
1	A	35	61%
2	B	10	18%
3	C	7	12%
4	D	5	9%

**Table 22: Activity 01 Listen then match**

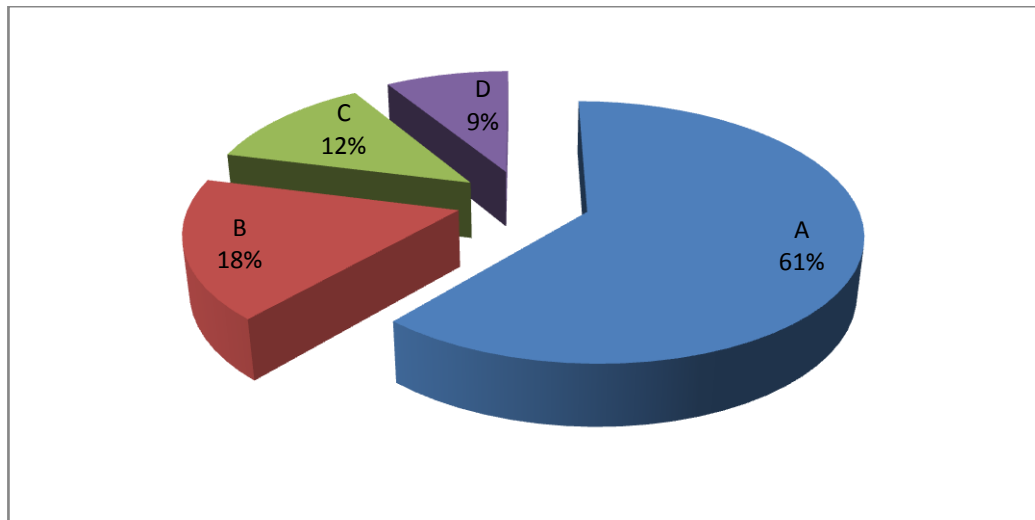

Figure 23: Activity 01 Listen then match

The results in table 22 Show that 61% from the answers of pupils are correct "A" level, 18% for "B" level, 12% "C" level and 9% "D" level from here we can notice that most of the pupils answered correct answers in the activity of listening comprehension.

**Activity 02: This activity contains question about written comprehension**

**Trace and write your Age in numbers:**

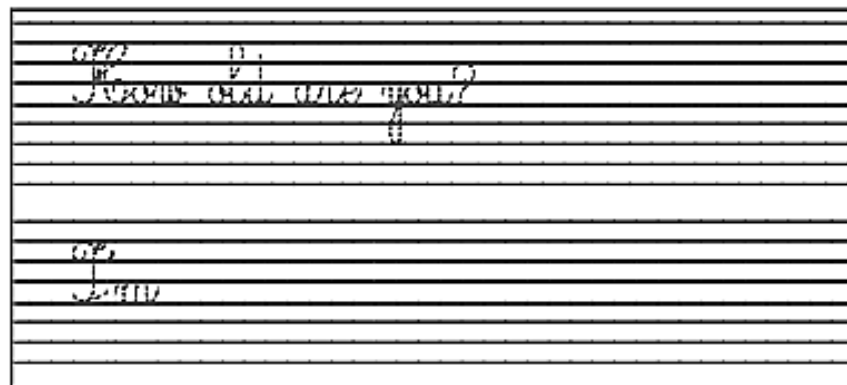
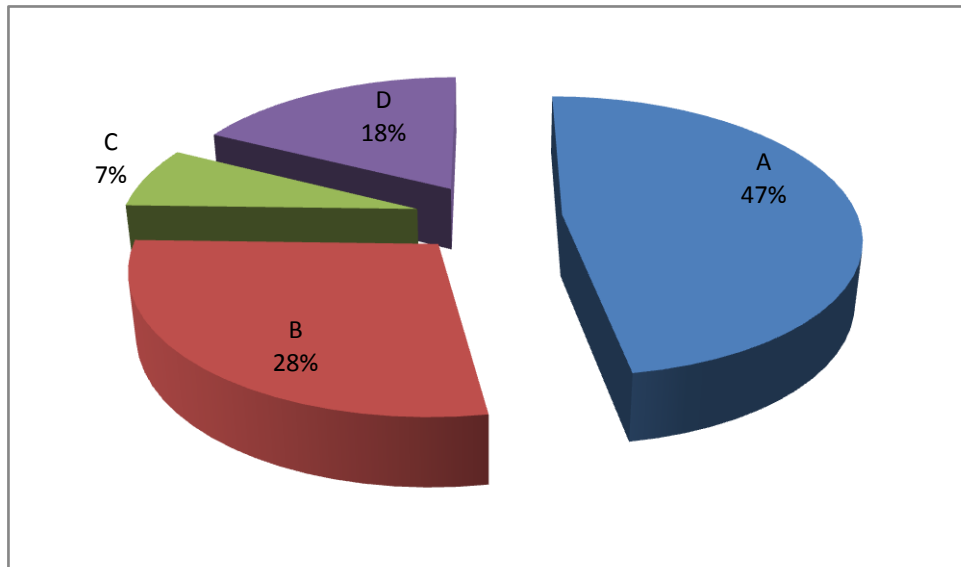

Figure 24: Activity 02 Trace and write

	Level	Number of pupils	Percentage
1	A	27	47%
2	B	16	28%
3	C	4	7%
4	D	10	18%

Table 23: Activity 02 Trace and write

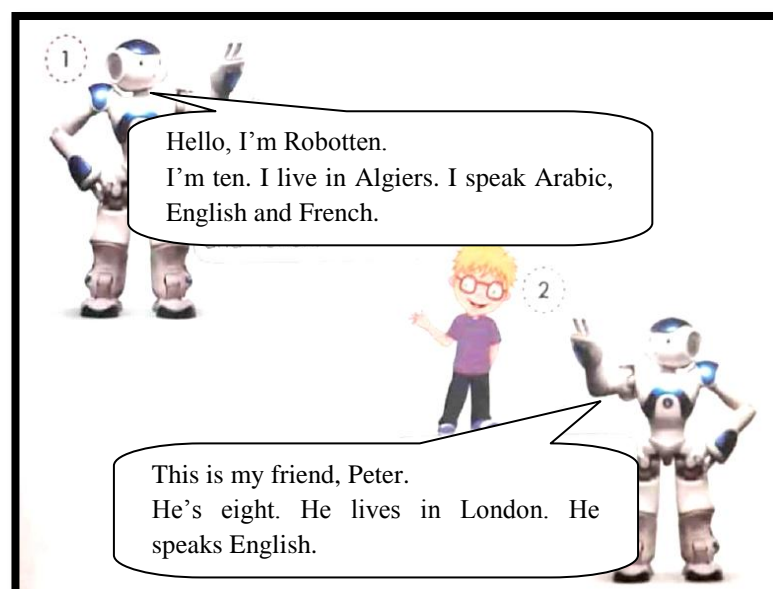

**Figure 25: Activity 02 Trace and write**

The results in table 23 Show that 47 %from the answers of pupils are "A" level, 28% for "B" level, 7% "C" level and 18% "D" level from here we can notice that in written comprehension pupils has deferent level in writing and the percentage of "D" level slightly elevated .

**Activity 03: This activity contains two phrases to read.**

**Read and do the same with your friend**



**Figure 26: Activity 03 Read and do the same with your friend**

	Level	Number of pupils	Percentage
1	A	17	30%
2	B	7	12%
3	C	15	26%
4	D	18	32%

**Table 24: Activity 03 Read and do the same with your friend**

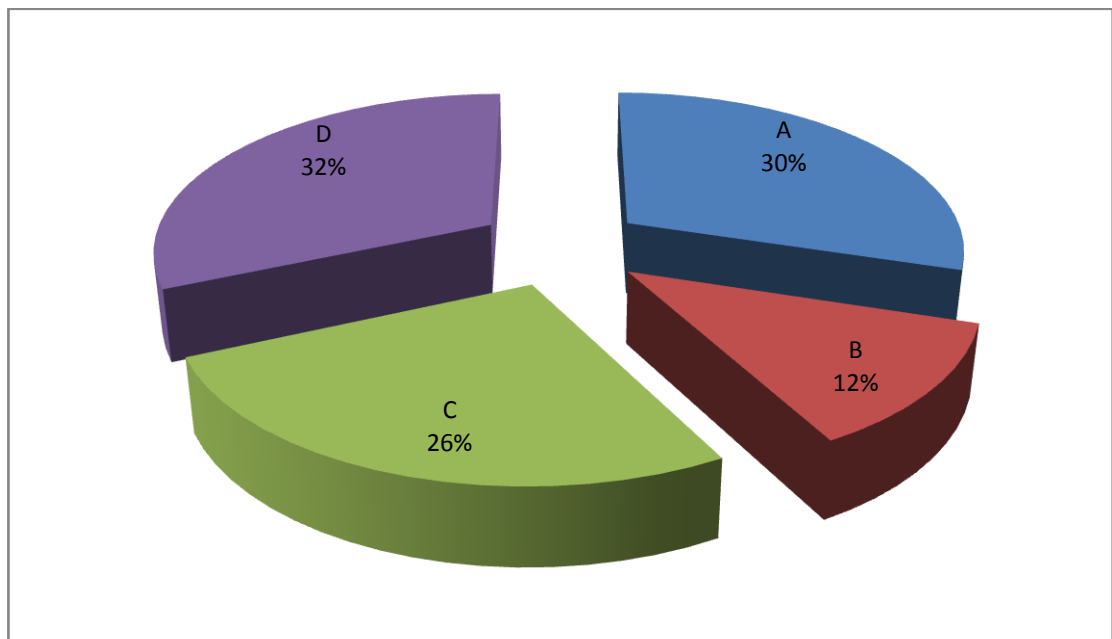

**Figure 27: Activity 03 Read and do the same with your friend**

The results in table 24 Show that 30 %from the answers of pupils are "A" level, 12% for "B" level, 26% "C" level and 32% "D" level from here we can say notice that in reading comprehension the most of pupils has "D" the majority of them have got bad results and only 30% from them are good in reading .

**Activity 04:** This activity contains questions about Greeting, school things, house rooms, toys and pets about speaking comprehension.

1- **Greeting**  
Hello, how are you?

2- **School things**  
What is this?

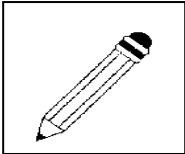
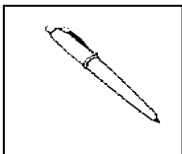
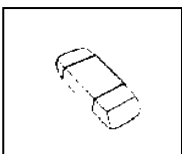
3- **House rooms**  
What is this?

4- **Toys and pets**  
What is this?

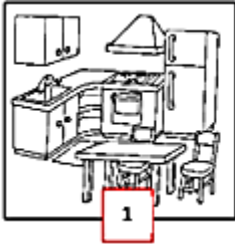
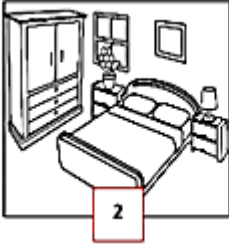
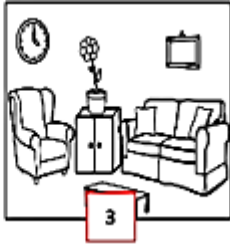
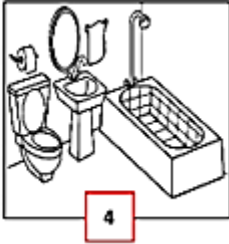

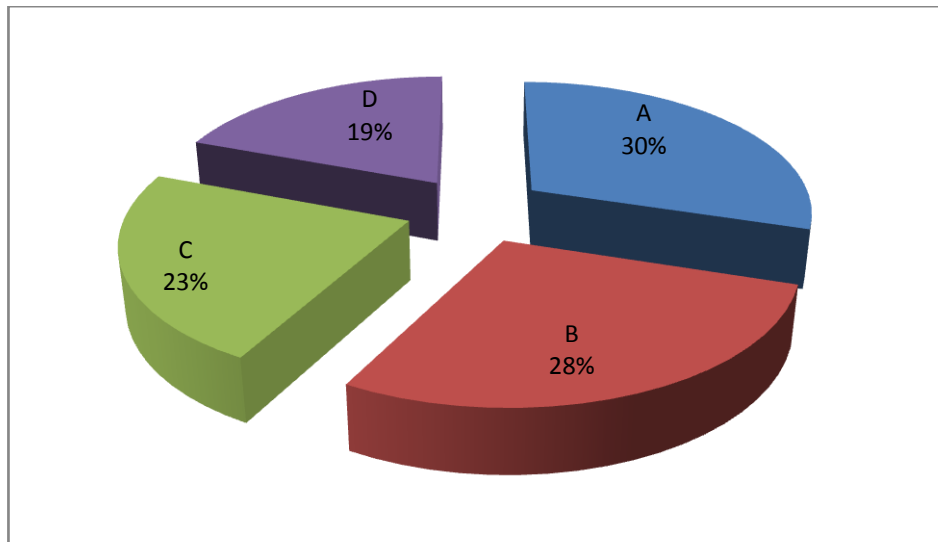



Figure 28: Activity 04speaking comprehension

	Level	Number of pupils	Percentage
1	A	17	30%
2	B	16	28%
3	C	13	23%
4	D	11	19%

Table 25: Activity 04 speaking comprehension





**Figure 29: Activity 04 speaking comprehension**

The results in table 25 Show that 30 %from the answers of pupils are "A" level, 28% for "B" level, 23% "C" level and 19% "D" level from here we can say notice that in speaking comprehension the most of pupils has "A" the majority of them has got good result and only 19% from them are bad in speaking .

"A" level:

- Hello, how are you? → I am fine thank you
- What is this?
  - This is a pen
  - This is a school bag
  - This is eraser
- What is this?
  - This is a kitchen
  - This is a bedroom
  - This is a living room
  - This is a bathroom
- What is this?
  - This is a doll
  - This is a dog
  - This is a cat

### 3.3 Analysis of the interview

**Question one:**

- What are the main competences -the primary school-that the teacher should focus on?
- **The answer of teacher:** Mainly oral comprehension: listening and speaking.

From the answer of the teacher we can say that listening and speaking skills in primary school more important than writing and reading in the learning process.

**Question two:**

- What are the techniques, that the teacher can be used to facilitate the comprehension of pupils?
- **The answer of teacher:** Suggest total physical response and translation.

From the suggestion of the teacher we can say that total physical response and translation are useful in the teaching and learning process and helpful for pupils in order to understand.

**Question three:**

- How can the teacher evaluate the comprehension of pupils in the classroom?
- **The answer of teacher:** Concept comprehension questions: indirect questions that measure how much a pupil know.

Here the teacher evaluates the pupil by indirect questions to measure the pupil's level of knowledge.

**Question four:**

- What do you think of the training offered to you as a teacher?
- **The answer of the teacher:** Hardly, the training is very theoretical and far from real classroom practice.

From here we can say that the training needs to be theoretical and practical to be more effective.

**Question five:**

- What are the aspects that the training focused on?
- **The answer of teacher:** Bloom's taxonomy, the importance of planning, types of testing.

The same remark of the previous question it is only theoretical training.

**Question six:**

- Do you invite your learners to interact?
- **The answer of teacher:** Definitely, I focus on functions rather than structures and grammar.

From here we can say that the teacher helps her pupils in a very effective way to interact, it is very important in order to raise the level of comprehension and learning of pupils.

**Question seven:**

- Do you encourage you learners to share ideas?
- **The answer of teacher:** Yes, to some extent. I encourage topic-related sharing.

Sharing ideas between learners build a solid foundation, it is something positive and the teacher here is doing a great thing.

**Question eight:**

- Do you encourage your learners to disagree with each others' view sand ideas?
- **The answer of teacher:** Yes, to some extent, we have to remember that a few topics presented in the book are argumentative. We had a conversation one day on whether a birthday party is a good thing; some pupils argued that it is unreligious.

From here we can notice that some pupils cannot disagree with each other in the correct way because they are beginners.

**Question nine:**

- Do you invite your pupils to negotiate meaning together?
- **The answer of teacher:** Sometimes, however most of the conversations aren't in English.

From here we can say that pupils at this level cannot carry on a proper language conversation because they are beginners and they know only few terms.

**Question ten:**

- Do you invite your learners to reflect on their learning experiences?
- **The answer of teacher:** Yes and no, I tend to collect their views indirectly because pupils at this stage are mostly people pleasers, they tell you what you want to hear. When I hear them say for example: "I can't believe the session is over!" I get that the lesson has been relatively fun and motivational.

From here we can say that teacher invite learners to reflect on their learning experiences to know what is going on in their minds and to collect their views and this is good because teacher here can measure the level of learners.

#### **4. Discussion of the results**

The data obtained from the teachers' questionnaire reveal that most of them are teaching in large classes and the number of pupils in the classroom is more than 25. And the time of each session is only 45 minutes, likewise, the number of weekly sessions is not enough for the pupil to learn all the skills in an ideal way, and what we noticed is that teaching in several schools by one teacher is stressful, and this is reflected on the teacher in a negative way. In terms of training, there is a big shortage because training in the theoretical aspect is not sufficient alone, practical training is needed. And about materials, the teacher's answers show lack of materials. The teachers who referred to this obstacle see that the English language will never gain the desired status since the needed materials are not sufficiently available. ( 13% flash aids, 3% data show the same percentage for games, also 3% others materials and also 3% from computer .) They added that in spite of the developed technologies, the students still practice English with old materials, especially be it primary schools, like using images.

Teaching under CBA requires means in order to reach good results. However, the teacher is doing great efforts in order to help pupils to reach a good level in all the skills. The recent educational reform recommends the adoption of the competency-based approach to language teaching which boosts the students to become autonomous in their learning and real life tasks (that 71% from teachers are guiders). And, these objectives were reached. Through the results of the questionnaire, we noticed that most of the pupils are good in listening and speaking skills, and some of them are also good at writing and reading, but in small percentages. According to Richards and Rodgers, some competencies are difficult to develop. In the CBA, it is not sufficient for students to understand, but they have to perform, and this is impossible in our case because of the problem of large classes.

The data obtained from the pupils' test reveal that most of them are good in speaking and listening skills. It is also shown that a noticeable percentage among the pupils level, a rate which proves that many of them are good in listening and speaking skills. It is clearly shown from the data obtained that not all of them are good in reading and writing skills. Competency-based approach helps increase pupils' comprehension skills in general especially listening and speaking.

It can be concluded from the results of the interview that the competences -the primary school-that the teacher should focus on are mainly oral comprehension listening and speaking. And as a type of assessment the teacher use indirect questions that measure how much a pupil know.

From the teacher's answer of **Q4** lack of practical training affect negatively on both teaching and learning process. From the answers of **Q6** and **Q7**, the teacher focuses on functions rather than structures and grammar and this is the goal of CBA which reflect a pupil's positive attitudes toward competency-based approach.

From the answer of **Q9** we can say that pupils at this level cannot carry on a proper language conversation because they are beginners and they know only few terms, and the last answer of **Q10** teacher invite learners to reflect on their learning experiences and it is such positive in order to know the pupil's level. In sum, the results discussed in the analysis of the teachers' questionnaire, the pupil's test and the teacher' interview confirm the initially stated hypothesis.

### **Conclusion**

This chapter represents the empirical study of our work. It consists of teacher's questionnaire, teacher's interview and pupil's test, a questionnaire which are delivered to teachers and pupils at the level of primary school in order to test their understanding under CBA, its effectiveness in the pupils' comprehension abilities at the primary school as well. In this chapter, we have extensively dealt with these three data tools both teachers' questionnaire and interview, and the pupil's test their results and analysis. Furthermore, we have also tackled the synthesis of the results obtained to address and answer the question problem investigates whether this new approach is effectively practiced in primary schools in Algeria, and hypotheses.

## General Conclusion

---

The objective of this dissertation was to investigate the effectiveness of the CBA in the pupils' comprehension abilities and the Algerian primary school English teachers' perceptions and views of CBA. This research was built upon two main parts. The theoretical and practical. The first part consisted of two chapters which were the theoretical part of the study in which were viewed shortly the major language teaching approaches and methods; in the first chapter we examined CBA background in detail (historical account, definition, components, objectives, principles and its implementation in Algerian primary school context.)The second chapter was about the comprehension abilities, this second chapter has provided a general overview of English comprehension abilities. After giving a general overview about comprehension abilities, we moved to speak about the types of tasks and activities in the classroom, the use of materials in the classroom, lesson planning, textbook of 3rd year primary school, topics and communicative objectives, role of the textbook in the classroom and the evaluation under the CBA and the second part represented the practical part of this research. In both parts, data collection was accomplished via three tools: teachers' questionnaire, teachers' interview and pupils' test. In chapter two, the questionnaire was administered to 7 teachers (from all the primary schools of Metlili (32 primary schools) each one of them teach in four or five schools). In part two, the test was given to 3rd year pupils at Ibn Badiss primary school of Metlili, 57 pupils from the same level. The analysis of all teachers' questionnaires, interview and pupils' test findings reveal that most of the teachers have a good understanding of CBA in what relates to its theoretical aspects, yet, it is not the case concerning practice. On the other hand, most of the pupils prefer the listening and speaking skills than the reading and the writing skills.

## REFERENCES

---

- Abbas Pourhosein Gilakjani(2016)** Department of English Language Translation, Islamic Azad University Lahijan Branch, Lahijan, Iran Narjes Banou Sabouri Department of Linguistics, Payame Noor University, Tehran, Iran The Significance of Listening Comprehension in English Language Teaching Theory and Practice in Language Studies, Vol. 6, No. 8, pp. 1670-1677.
- Abdellah Yellas & Fatima Belalta (2016)** Teaching English to Primary School Children in Algeria: An Evaluation by Parents and Former Pupils.master degree university of Mohammed Seddik Ben Yahia of Jijel .
- Alan burce(2014)** teaching and learning in competency based education Universal Learning Systems [abruce@ulsystems.com](mailto:abruce@ulsystems.com) The Fifth International Conference on e-Learning (eLearning-2014), 22-23 September 2014,Belgrade, Serbia.
- Anthony, E. M. (1963).** Approach, method and technique. English Language Teaching.
- Arafat Hamouda(2013)** An Investigation of Listening Comprehension Problems Encountered by Saudi Students in the EL Listening Classroom . International Journal of Academic Research in Progressive Education and Development, Vol. 2, No. 2
- Auerbach,E.R.(1986).** Competency-based ESL: One step forward or two steps back?
- BADER & Hacene HAMADA(2015)** Competency Based Approach Between Theory And Practice · January 2015 Faiza Teacher Training School (ENS) Constantine (Algeria) <http://glendapaul62.blogspot.com/>
- BENCHANAA Saad(2019/2020)** Discussing the possibility (s) of teaching English at primary school in Algeria Master thesis university of Biskra.

## REFERENCES

---

- Bowden, J.A.** (2004). Competency-based education: Neither panacea nor pariah  
[http://cm.htc.ac.ac/events/archive/tend/018\\_bowden.html](http://cm.htc.ac.ac/events/archive/tend/018_bowden.html)
- Brown.** (2000). Principles of Language Learning and Teaching (4th ed.). White Plains, NY Pearson Education.
- Cambridge dictionary** <https://dictionary.cambridge.org/>
- Carlous Muluh Nkwetisama** (2012) ,The Competency Based Approach to English Language Education and the Walls between the Classroom and the Society in Cameroon: Pulling Down the Walls Department of English and Literatures of English Expression, Higher Teachers“ Training College, University of Maroua, Maroua, Cameroon.
- Chelli, S.** (2010, January). The competency- based approach in algeria: a necessity in the era of globalization. revue de la faculté des lettre et sciences sociales, 6, 55 - 58.
- Chuzaimah Dahlan Diem, Soni Mirizon, Machdalena Vianty Sriwijaya** (2017) University, Indonesia STUDENTS’ SPECIFIC COMPREHENSION SKILLS IN ENGLISH BASED ON SCHOOL LOCATIONS, GRADES, AND GENDERi.
- CNP (2022 )** Ministry of National Education DIDACTIC GUIDE OF ENGLISH FOR 3rd YEAR PRIMARY EDUCATION
- CNP (2022)** SYLLABUS OF ENGLISH FOR PRIMARY SCHOOL YEAR 3
- Collins dictionary** <https://www.collinsdictionary.com/>
- Cortazzi and Jin** (1999) Materials and methods in the EFL classroom
- David Nunan (2003)** PRACTICAL ENGLISH LANGUAGE TEACHING, FIRST EDITION International Edition.



## REFERENCES

---

- Davies,& Pearse**, (2000). Success in English Teaching. Oxford University Press.
- DeSeCo**(2002) definition and selection of competencies Theoretical and conceptual foundations. Retrieved May,24,2013, from <http://www.Deseco.admin.ch>.
- Djihed Azerouel Nadjette Malki** (2020/2021) Language Policy Changes and Educational Reforms in Algeria: Re-Implementing Teaching English at Primary Schools university OUM EL BOUAGHI
- Docking,R.**(1994).Competency-based curricula- The big picture. Prospect ,9 (2) ,8 -17.
- ELT articles** (2009)“Introducing the CBA”
- Griffith and Lim** (2014) . Introduction to Competency-Based Language Teaching. Mextesol journal 38(2), 1-8.
- Harmer**. (2001). The Practice of English Language Teaching (3rd ed.). Harlow Longman.
- Hedge, T.** (2000), Teaching and learning in the language classroom. Oxford University Press.
- <https://www.a-onec.com/>
- Jack C. Richards and Theodore S Rodgers**(1986) Approaches and Methods in Language Teaching A description and Analysis . Cambridge Language Teaching Library.
- John Burke** (1989 ) Competency Based Education and Training London • New York • Philadelphia.
- Knouwenhoven, W.** Competency- based curriculum development in higher education.RetrievedMarch10,2012

## REFERENCES

---

[http://dare.uvu.vu.n/bistsream/1871/158116/6720competence-based development in higher education.some20experience20 Knouwenhoven.pdf.](http://dare.uvu.vu.n/bistsream/1871/158116/6720competence-based%20development%20in%20higher%20education.some20experience20%20Knouwenhoven.pdf)

**Leila Bellour** (2017) The Competency Based Approach and its Discontents in the Algerian Secondary Schools Department of Foreign Languages Abdelhafid Boussouf University Center of Mila

**Lilian F. Wiisahnyuy(2021)**, Ph.D The Competency Based Approach in Cameroon Public Secondary The Competency Based Approach in Cameroon Public Secondary Higher Teacher Training College, The University of Bamenda, Po Box 39, Bambili Cameroon (92.103)

**Littlewood, W.** (1981). Communicative language teaching Cambridge: Cambridge University Press.

**Mohamed Audi (2014/2015)**, Master in language studies Reading Comprehension Difficulties among EFL the Case of Third-Year Learners At Nehali Mohamed Secondary School University of Tlemcen

**New Oxford Advanced Learner's Dictionary** (2005)

<https://www.oxfordlearnersdictionaries.com/>

**Nunan, David** (2003). Practical English Language Teaching

**Paul, G.** (2008). Competency-Based Language Teaching Report.

[Http://glendapaul62.blogspot.com./2008/12/competency-based-teaching.html](http://glendapaul62.blogspot.com./2008/12/competency-based-teaching.html)

**Québec Education Programme** (2001)

**Richards, J. C.** (2001). Curriculum Development in Language Teaching. Cambridge University Press.

**Richards, J. C., & Richard S.** (2002). Longman: Dictionary of Language teaching and applied linguistics.

## REFERENCES

---

**Safia Adejrout** (2020) Investigating the Effectiveness of the Competency-based Approach in Developing Learners' Writing Proficiency: The Case of Second Year Secondary School Pupils- Jijel Thesis Submitted to the Department of Letters and English in Candidacy for the Degree of Doctorat "Es Sciences" in Applied Linguistics.

**Samia Boudouda & Nadia Khelkhal (2011/2012)** Problems Facing Teachers in Implementing the Competency-Based Approach in Teaching Writing: A Case Study of EFL Secondary School Teachers in Batna Master thesis.

**Slimane BOUKHENTACHE** (2020) Teaching Language Skills in Competency-Based Approach: Practical Guidelines ALTRALANG Journal Volume 02 Issue 02 /

**vocabulary.com dictionary** <https://www.vocabulary.com/dictionary/>

**Weddel, K.S.**(2006). Competency-Based Education and Content Standards. Northern Colorado Literacy Resource Center

# Appendix A

## Questionnaire

Dear teacher

You are kindly asked to answer this questionnaire which is an important part of an academic investigation that aims to Investigate the effectiveness of Competency-Based Approach (CBA) in developing primary education pupils' English comprehension ability. your answers and suggestions will be very helpful and useful in our research project.

Please tick the appropriate box or write full statements when necessary.

### Section one: Teaching Methodology

1- To which extent do you rely on the textbook provided by the ministry of education?

- Always
- Usually
- Rarely
- Never

2- How often do you use the mother tongue in classroom explanation?

- Always
- Usually
- Some times
- Never

3- How often do use CBA?

- Always
- Usually
- Some times
- Never

4- The teacher's role in the CBA should be :

- A facilitator

A conventional information-provider

Guider

Explain your choice, please: .....

**5- Do learners interact with each other?**

Always

Usually

Some times

Never

**6- Which of the following skills your pupils best prefer ?**

Listening

Speaking

Reading

Writing

**7- Do you praise your learners?**

Always

Usually

Some times

Never

**08-Which ones of the following materials/techniques do you use in the classroom**

Role play

Flash aids

Games

Songs

Images

Teachers' gestures

Computer

Data show

Others

Justify your answer.....

.....

**09- Does the textbook help the learner to work in pairs or groups ?**

Yes

No

If no , please explain why ?.....

**10-Do you feel that the textbook is appropriate for the pupil's level**

Yes

No

**11-Do you have tests to evaluate pupils' level, if yes how?**

**12-Do you encourage classroom interaction, If yes how?**

### **Section two: Difficulties Faced in Teaching English**

**1-Is time sufficient for teaching English**

Yes

No

Somehow

**2-Do you have difficulties of teaching large classes**

Yes

No

To some extent

**3-The number of pupils in each class is :**

Less than 25 students

Between 30 and 40 students

More than 40 students

**4-Do you have the needed materials to teach English in primary school**

Yes

No

**5-Do you have enough instruction and guidance needed in teaching process**

Yes

No

**6-Do the learners engage and interact with the learning process**

Yes

No

**7-Do you have difficulties in teaching at different schools**

Yes

No

**8-How can you help your pupils who do not understand the task?**

**9-According to you as a teacher what are the causes behind your classroom's problems?**

Lack of time

Lack of information

The huge number of pupils

**Others, please specify .....**

**Appendix B**

**THE TEST**

**Activity 01: This activity contains one question about listening comprehension**

**Listen then match the word with the sound /D/**

<b>Lamb</b>	<b>Cat</b>	<b>Cup</b>
<b>Doll</b>	<b>D</b>	<b>Dog</b>
	<b>Long</b>	

**Activity 02: This activity contains question about written comprehension**

**Trace and write your Age in numbers:**

**Activity 03: This activity contains two phrases to read.**

**Read and do the same with your friend**



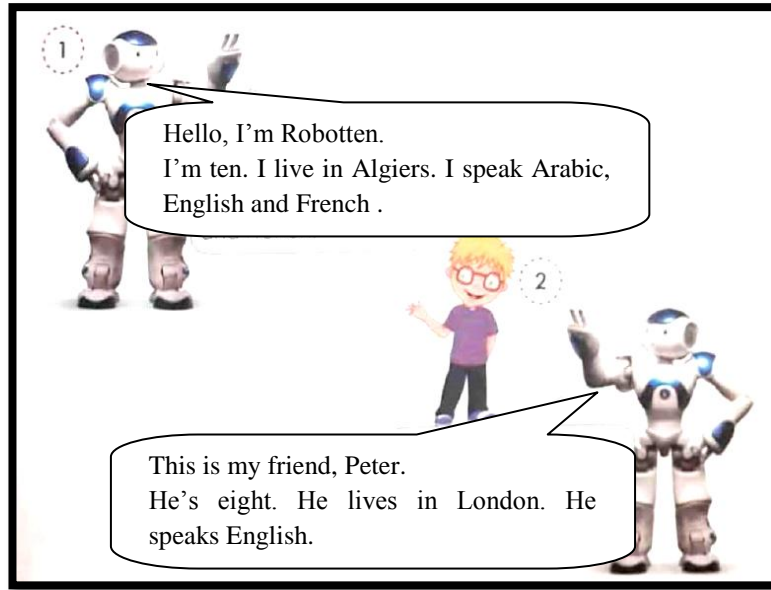



**Activity 04:** This activity contains questions about Greeting, school things, house rooms, toys and pets about speaking comprehension.

**1- Greeting**  
**Hello, how are you?**

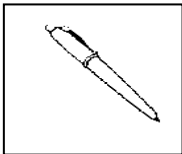
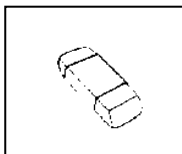
**2- School things**  
**What is this?**

**3- House rooms**  
**What is this?**



1

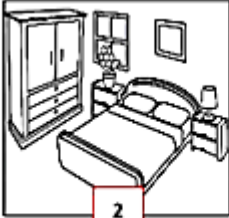

2

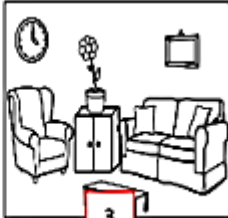



3



4

**4- Toys and pets**  
**What is this?**

## Appendix D

### The teacher interview

#### 3 Analysis of the interview

##### Question one:

- What are the main competences -the primary school-that the teacher should focus on?
- **The answer of teacher:** Mainly oral comprehension: listening and speaking.

##### Question two:

- What are the techniques, that the teacher can be used to facilitate the comprehension of pupils?
- **The answer of teacher:** Suggest total physical response and translation.

##### Question three:

- How can the teacher evaluate the comprehension of pupils in the classroom?
- **The answer of teacher:** Concept comprehension questions: indirect questions that measure how much a pupil know.

##### Question four:

- What do you think of the training offered to you as a teacher?
- **The answer of teacher:** Hardly, the training is very theoretical and far from real classroom practice.

##### Question five:

- What are the aspects that the training focused on?

**The answer of teacher:** Bloom's taxonomy, the importance of planning, types of testing.

##### Question six:

- Do you invite your learners to interact?
- **The answer of teacher:** Definitely, I focus on functions rather than structures and grammar.

##### Question seven:

- Do you encourage you learners to share ideas?
- **The answer of teacher:** Yes, to some extent. I encourage topic-related sharing.

##### Question eight:

- Do you encourage your learners to disagree with each others' views and ideas?

- **The answer of teacher:** Yes, to some extent, we have to remember that a few topics presented in the book are argumentative. We had a conversation one day on whether a birthday party is a good thing; some pupils argued that it is unreligious.

**Question nine:**

- Do you invite your pupils to negotiate meaning together?
- **The answer of teacher:** Sometimes, however most of the conversations aren't in English.

**Question ten:**

- Do you invite your learners to reflect on their learning experiences?
- **The answer of teacher:** Yes and no, I tend to collect their views indirectly because pupils at this stage are mostly people pleasers, they tell you what you want to hear. When I hear them say for example: "I can't believe the session is over!" I get that the lesson has been relatively fun and motivational.

## Appendix E

### Topics and Communicative Objectives

#### TOPICS AND COMMUNICATIVE OBJECTIVES

TOPICS	COMMUNICATIVE OBJECTIVES
<b>ME, MY FAMILY AND MY FRIENDS</b>	<ul style="list-style-type: none"><li>- Greeting people/Leave taking</li><li>- Introducing oneself, family, friends</li><li>- Saying numbers</li><li>- Asking about age and place of residence</li></ul>
<b>MY SCHOOL</b>	<ul style="list-style-type: none"><li>- Naming school objects</li><li>- Naming colours</li><li>- Asking about and locating school objects</li><li>- Naming days of the week</li><li>- Asking about school timetable</li></ul>
<b>MY HOME</b>	<ul style="list-style-type: none"><li>- Naming rooms</li><li>- Asking about their location</li><li>- Locating people inside a house</li><li>- Following instructions</li></ul>
<b>MY PLAYTIME</b>	<ul style="list-style-type: none"><li>- Naming and asking about favourite toys</li><li>- Identifying toys</li><li>- Asking about colours</li></ul>
<b>MY PETS</b>	<ul style="list-style-type: none"><li>- Naming pets</li><li>- Describing pets: identifying their size and parts</li><li>- Asking and giving information about pets</li></ul>
<b>MY FANCY BIRTHDAY</b>	<ul style="list-style-type: none"><li>- Naming objects and foods related to birthday celebration</li><li>- Naming different face parts</li><li>- Expressing offers and thanks</li><li>- Responding to offers and thanks</li><li>- Expressing wishes, feelings and emotions</li><li>- Following instructions</li></ul>

Table2: Topics and Communicative Objectives

في السياق الحالي لدينا اللغة الإنجليزية – كلغة جديدة – في المدرسة الابتدائية و المقاربة بالكفاءات كأحد مناهج التعلم، وقد أدخلته المدارس الجزائرية في منهج اللغة الإنجليزية الجزائري حسب احتياجات التلاميذ. الهدف من هذه الدراسة هو التحقيق في تنمية القدرة على فهم اللغة الإنجليزية لدى تلاميذ المرحلة الابتدائية في السنة الثالثة ابتدائي، وتحديد قدرتهم على الفهم بموجب المقاربة بالكفاءات. أجريت هذه الدراسة على عينة مكونة من 7 أساتذة للغة الإنجليزية و57 تلميذا من السنة الثالثة في ابتدائية ابن باديس بمتنلي. استخدم الباحثان الاستبيان، الاختبار و المقابلة كأدوات لجمع البيانات. تكشف النتائج أن معظم المعلمين لديهم فهم جيد للمقاربة بالكفاءات فيما يتعلق بالجانب النظري، وعكس ذلك تمامًا فيما يتعلق بالممارسة (الجانب التطبيقي). من ناحية أخرى، يفضل معظم التلاميذ مهارات الاستماع والتحدث على مهارات القراءة والكتابة.

**الكلمات المفتاحية:** المقاربة بالكفاءات، القدرة على فهم اللغة الإنجليزية، المهارات اللغوية، مدرسة ابن باديس الابتدائية.